



English

Français

Español

DAIKIN ROOM AIR CONDITIONER

OPERATION MANUAL

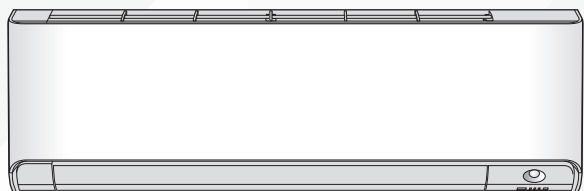

Enjoy year-round comfort.

MODELS

FTXM09WVJU9
FTXM12WVJU9
FTXM18WVJU9
FTXM24WVJU9

[Sticker attachment area]

Attach the serial number sticker of wireless LAN connection adapter to the sticker attachment area and keep safe.

Features

Enhanced comfort and energy savings



2-AREA INTELLIGENT EYE FTXM09WVJU9 / FTXM12WVJU9

The INTELLIGENT EYE sensor detects human movement and adjusts the right and left airflow direction. If no one is in the room for more than 20 minutes, the operation automatically changes to energy saving operation. The INTELLIGENT EYE sensor works differently depending on the situation. [▶Page 19](#)



INTELLIGENT EYE FTXM18WVJU9 / FTXM24WVJU9

The INTELLIGENT EYE sensor detects human movement in a room. If no one is in the room for more than 20 minutes, the operation automatically changes to energy saving operation. [▶Page 21](#)



WEEKLY TIMER

Up to 4 timer settings can be saved for each day of the week according to your family's lifestyle. The WEEKLY TIMER allows you to set on/off times and the desired temperature. [▶Page 29](#)



CLEAN

The CLEAN function dries the interior of the indoor unit to reduce the amount of condensation present. [▶Page 17](#)

Other functions



COMFORT AIRFLOW

The airflow direction is upward while in COOL operation, and downward while in HEAT operation. This function prevents cold or warm air from blowing directly on your body. [▶Page 23](#)



QUIET OUTDOOR UNIT



QUIET OUTDOOR UNIT operation assures a lower noise level of the outdoor unit. This function is useful to maintain a quiet neighborhood. [▶Page 25](#)

Contents







■ Read Before Operation

Safety Considerations	3
Names of Parts	5
Preparation Before Operation	10



■ Basic Operation

 AUTO · DRY · COOL · HEAT · FAN Operation	13
 Adjusting the Airflow Rate	15
 Adjusting the Airflow Direction	16

■ Useful Functions

 CLEAN Operation	17
 2-AREA INTELLIGENT EYE Operation ...	19
<small>FTXM09WVJU9 / FTXM12WVJU9</small>	
 INTELLIGENT EYE Operation	21
<small>FTXM18WVJU9 / FTXM24WVJU9</small>	
 COMFORT AIRFLOW Operation	23
 POWERFUL Operation	24
 ECONO / QUIET OUTDOOR UNIT Operation	25

■ TIMER Operation

 ON/OFF TIMER Operation	26
 WEEKLY TIMER Operation	29

■ Mobile Controller

 Wireless LAN connection	35
---	----

■ Care

Care and Cleaning	41
-------------------------	----

■ When the Need Arises

FAQ	45
Troubleshooting	46





ECONO

This function enables efficient operation by limiting the maximum power consumption. It is useful when using the air conditioner and other electrical devices simultaneously on a shared electrical circuit. ▶Page 25

Safety Considerations

Refer also to the General Safety Considerations in the separate booklet.

	Read the precautions in this manual carefully before operating the unit.
 A2L	This appliance is filled with R32.

Read these **Safety Considerations for Operations** carefully before operating an air conditioner or heat pump.

Make sure that the unit operates properly during the startup operation. Instruct the user on how to operate and maintain the unit. Inform users that they should store this operation manual with the installation manual for future reference.

Meanings of **DANGER**, **WARNING**, **CAUTION**, and **NOTE** Symbols:

 **DANGER** Indicates an imminently hazardous situation which, if not avoided, will result in death or serious injury.

 **WARNING** Indicates a potentially hazardous situation which, if not avoided, could result in death or serious injury.

 **CAUTION** Indicates a potentially hazardous situation which, if not avoided, may result in minor or moderate injury. It may also be used to alert against unsafe practices.

 **NOTE** Indicates situations that may result in equipment or property-damage accidents only.

DANGER

- Do not install the unit in an area where flammable materials are present due to risk of explosion resulting in serious injury or death.
- Any abnormalities in the operation of the air conditioner or heat pump, such as smoke or fire, could result in severe injury or death. Turn off the power and contact your dealer immediately.
- Refrigerant gas may produce toxic gas if it comes into contact with fire, such as from a fan heater, stove, or cooking device. Exposure to this gas could cause severe injury or death.
- For refrigerant leakage, consult your dealer. Refrigerant gas is heavier than air and replaces oxygen. A massive leak could lead to oxygen depletion, especially in basements, and an asphyxiation hazard could occur leading to serious injury or death.
- If equipment utilizing a burner is used in the same room as the air conditioner or heat pump, there is the danger of oxygen deficiency which could lead to an asphyxiation hazard resulting in serious injury or death. Be sure to ventilate the room sufficiently to avoid this hazard.
- Safely dispose of the packing materials. Packing materials, such as nails and other metal or wooden parts, may cause stabs or other injuries.

- Tear apart and throw away plastic packaging bags so that children will not play with them. Children playing with plastic bags face the danger of death by suffocation.

WARNING

- Contact your dealer for repair and maintenance. Improper repair and maintenance may result in water leakage, electric shock, and fire. Only use accessories made by Daikin that are specifically designed for use with the equipment and have them installed by a professional.
- Contact your dealer to move and reinstall the air conditioner or heat pump. Incomplete installation may result in water leakage, electric shock, and fire.
- Never let the indoor unit or the remote controller get wet. Water can cause an electric shock or a fire.
- Never use flammable spray such as hair spray, lacquer, or paint near the unit. Flammable spray may cause a fire.
- When a fuse blows out, never replace it with one of incorrect ampere ratings or different wires. Always replace any blown fuse with a fuse of the same specification.
- Never remove the fan guard of the unit. A fan rotating at high speed without the fan guard is very dangerous.
- Never inspect or service the unit by yourself. Contact a qualified service person to perform this work.
- Turn off all electrical power before doing any maintenance to avoid the risk of serious electric shock; never sprinkle or spill water or liquids on the unit.
- Do not touch the switch with wet fingers. Touching a switch with wet fingers can cause electric shock.
- Do not allow children to play on or around the unit to prevent injury.
- The heat exchanger fins are sharp enough to cut. To avoid injury wear gloves or cover the fins while working around them.
- Do not put a finger or other objects into the air inlet or air outlet. The fan is rotating at high speed and will cause injury.
- Check the unit foundation for damage on a continuous basis, especially if it has been in use for a long time. If left in a damaged condition the unit may fall and cause injury.
- Placing a flower vase or other containers with water or other liquids on the unit could cause a shock or fire if a spill occurs.
- Do not touch the air outlet or horizontal blades while the swing flap is in operation because fingers could get caught and injured.
- Never touch the internal parts of the controller. Do not remove the front panel because some parts inside are dangerous to touch. To check and adjust internal parts, contact your dealer.
- Do not use means to accelerate the defrosting process or to clean, other than those recommended by the manufacturer.
- The appliance must be stored in a room without continuously operating ignition sources (for example: open flames, an operating gas appliance or an operating electric heater).
- Do not pierce or burn.
- Be aware that refrigerants may not contain an odor.

⚠ CAUTION

- Do not use the air conditioner or heat pump for any other purposes other than comfort cooling or heating. Do not use the unit for cooling precision instruments, food, plants, animals or works of art.
- Do not place items under the indoor unit as they may be damaged by condensates that may form if the humidity is above 80% or if the drain outlet gets blocked.
- Before cleaning, stop the operation of the unit by turning the power off or by pulling the supply cord out from its receptacle. Otherwise, an electric shock and injury may result.
- Do not wash the air conditioner or heat pump with excessive water. An electric shock or fire may result.
- Avoid placing the controller in a spot which may be splashed with water. Water entering the controller may cause an electric shock or damage the internal electronic parts.
- Do not operate the air conditioner or heat pump when using a room-fumigation type of insecticide. Failure to observe this could cause the chemicals to be deposited in the unit and can endanger the health of those who are hypersensitive to chemicals.
- Do not turn off the power immediately after stopping operation. Always wait for at least 5 minutes before turning off the power. Otherwise, water leakage may occur.
- The appliance is not intended for use by young children or infirm persons without supervision.
- The remote controller should be kept away from children so they cannot play with it.
- Consult with the installation contractor for cleaning.
- Incorrect cleaning of the inside of the air conditioner or heat pump could make the plastics parts break and cause water leakage or electric shock.
- Do not touch the air inlet or aluminum fin of the air conditioner or heat pump as they can cut and cause injury.
- Do not place objects in direct proximity of the outdoor unit. Do not let leaves and other debris accumulate around the unit. Leaves are a hotbed for small animals which can enter the unit. Once inside the unit, animals can cause the unit to malfunction, and cause smoke or fire when they make contact with electrical parts.
- Do not wipe the controller operation panel with benzene, thinner, chemical dust cloth, etc. The panel may get discolored or the coating can peel off. If it is heavily dirty, soak a cloth in water-diluted neutral detergent, squeeze it well and wipe the panel clean. Then wipe it with another dry cloth.
- Dismantling of the unit, disposal of the refrigerant, oil, and additional parts, should be done in accordance with the relevant local, state, and national regulations.
- Operate the air conditioner or heat pump in a sufficiently ventilated area and not surrounded by obstacles. Do not use the air conditioner or heat pump in the following places.
 - a. Places with a mist of mineral oil, such as cutting oil.
 - b. Locations such as coastal areas where there is a lot of salt in the air.
 - c. Locations such as hot springs where there is a lot of sulfur in the air.
 - d. Locations such as factories where the power voltage varies a lot.
 - e. In cars, boats, and other vehicles.
 - f. Locations such as kitchens where oil may splatter or where there is steam in the air.
 - g. Locations where equipment produces electromagnetic waves.
 - h. Places with an acid or alkaline mist.
 - i. Places where fallen leaves can accumulate or where weeds can grow.
- Take snow protection measures. Contact your dealer for the details of snow protection measures, such as the use of a snow protection hood.
- Do not attempt to do electrical work or grounding work unless you are licensed to do so. Consult with your dealer for electrical work and grounding work.
- Pay attention to operating sound. Be sure to use the following places:
 - a. Places that can sufficiently withstand the weight of the air conditioner or heat pump yet can suppress the operating sound and vibration.
 - b. Places where warm air from the air outlet of the outdoor unit or the operating sound of the outdoor unit does not annoy neighbors.
- Make sure that there are no obstacles close to the outdoor unit. Obstacles close to the outdoor unit may drop the performance of the outdoor unit or increase the operating sound of the outdoor unit.
- Consult your dealer if the air conditioner or heat pump in operation generates unusual noise.
- Make sure that the drainpipe is installed properly to drain water. If no water is discharged from the drainpipe while the air conditioner or heat pump is in the cooling mode, the drainpipe may be clogged with dust or dirt and water leakage from the indoor unit may occur. Stop operating the air conditioner or heat pump and contact your dealer.
- Do not spray the air conditioner unit with any deodorizers, etc. It may cause the unit to malfunction.

⚠ NOTE

- Never press the button of the remote controller with a hard, pointed object. The remote controller may be damaged.
- Never pull or twist the electric wire of the remote controller. It may cause the unit to malfunction.
- Do not place appliances that produce open flames in places that are exposed to the airflow of the unit or under the indoor unit. It may cause incomplete combustion or deformation of the unit due to the heat.
- Do not expose the controller to direct sunlight. The LCD display can become discolored and may fail to display the data.

FTP002(R32)-U

Names of Parts

Indoor Unit

- The appearance of the indoor unit may differ between different models. (This is a 09/12 class illustration)

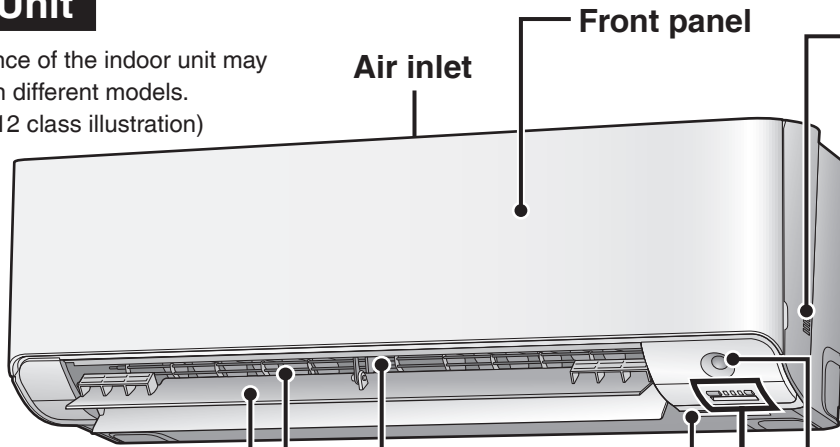

Flaps (horizontal blades)

▶ Page 16

Air outlet

Louvers (vertical blades)

- The louvers are inside of the air outlet.

▶ Page 16

Model name

Indoor temperature sensor and Indoor humidity sensor

- Sense air temperature and humidity around the unit.

INTELLIGENT EYE sensor

- Detects the movements of people and automatically switches between normal operation and energy saving operation.

▶ Page 19-22

Display

CLEAN lamp (Green)

▶ Page 17

TIMER lamp (Orange)

▶ Page 26, 27, 28, 31

Indoor unit ON/OFF switch and OPERATION lamp (Green)

- Press this switch once to start operation. Press once again to stop it.
- For the operation mode setting, refer to the following table.

Mode	Temperature setting	Airflow rate
AUTO	77°F (25.0°C)	AUTO

- This switch can be used when the remote controller is missing or out of batteries.

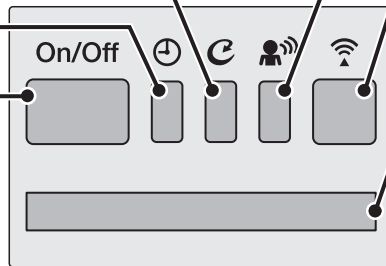

INTELLIGENT EYE lamp (Green)

▶ Page 19, 21

Wireless LAN connection adapter lamp (Orange)

▶ Page 9, 35

Signal receiver

- Receives signals from the remote controller.
- When the unit receives a signal, you will hear a beep sound.

Case	Sound type
Operation start	beep-beep
Setting change	beep
Operation stop	long beep

List of lamps

Lamp	Color	State	Description
OPERATION lamp	green	Lights up	The air conditioner is running.
		Blinks	Check the error code.
TIMER lamp	orange	Lights up	TIMER is set. ▶ Page 26, 27, 28, 31
CLEAN lamp	green	Lights up	CLEAN operation. ▶ Page 17
INTELLIGENT EYE lamp	green	Lights up	INTELLIGENT EYE operation. ▶ Page 19, 21
Wireless LAN connection adapter lamp	orange	Lights up	Wireless LAN connection adapter operation. ▶ Page 9, 35
		Blinks	Wireless LAN connection adapter is connected. ▶ Page 9, 35

■ Open the front panel

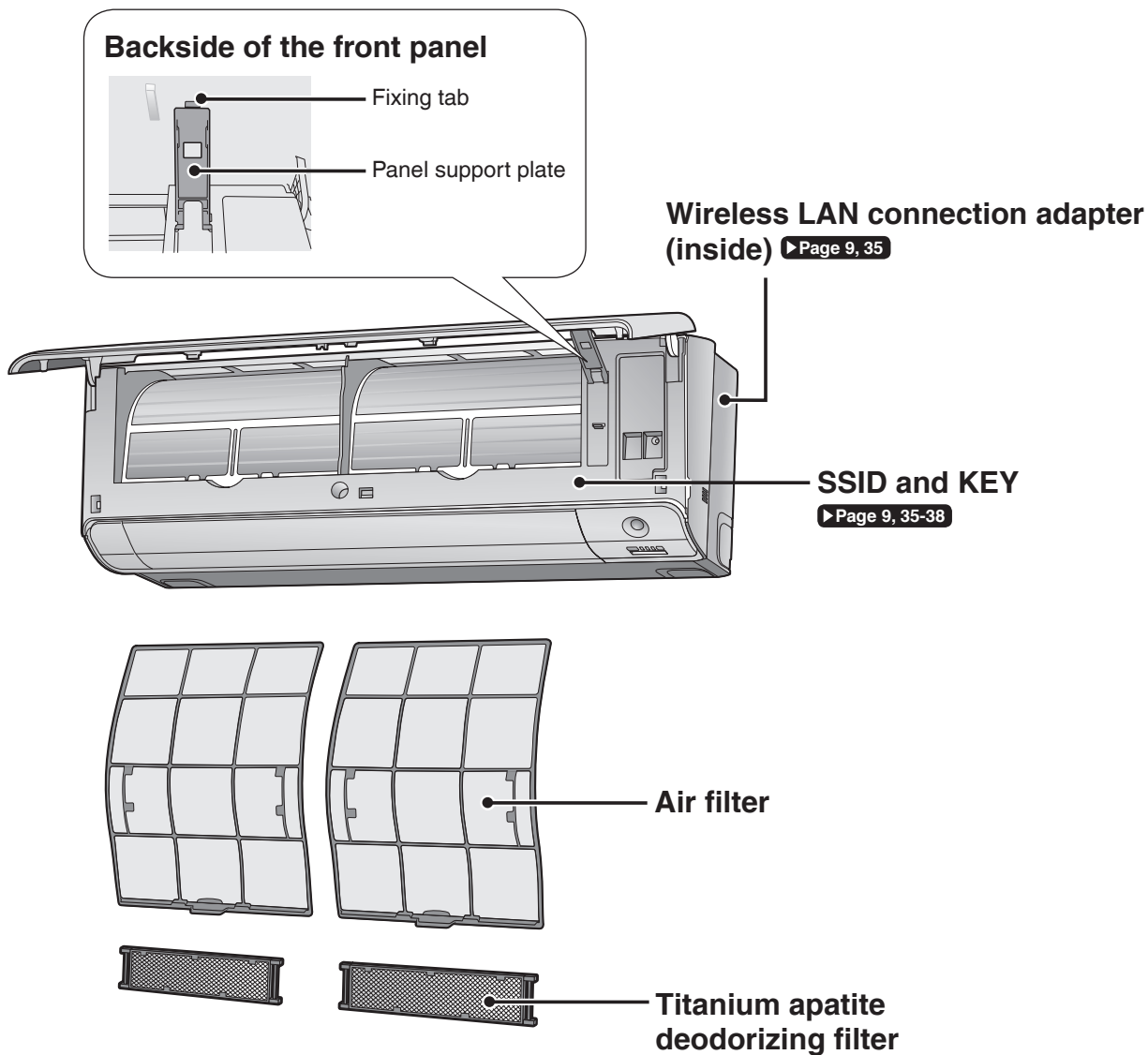

Outdoor Unit

- The appearance of the outdoor unit may differ between different models.
(This is a 09/12 class illustration)

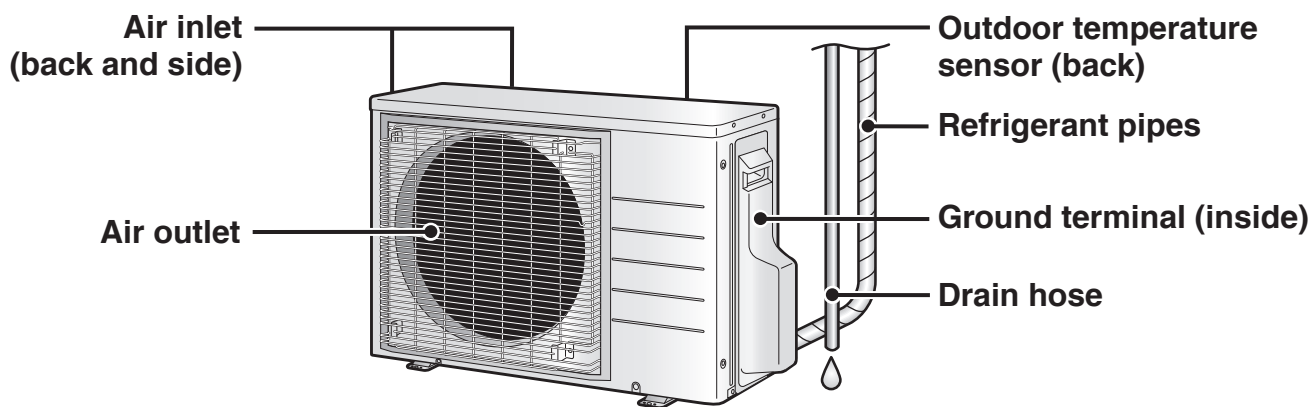

Names of Parts

Remote Controller

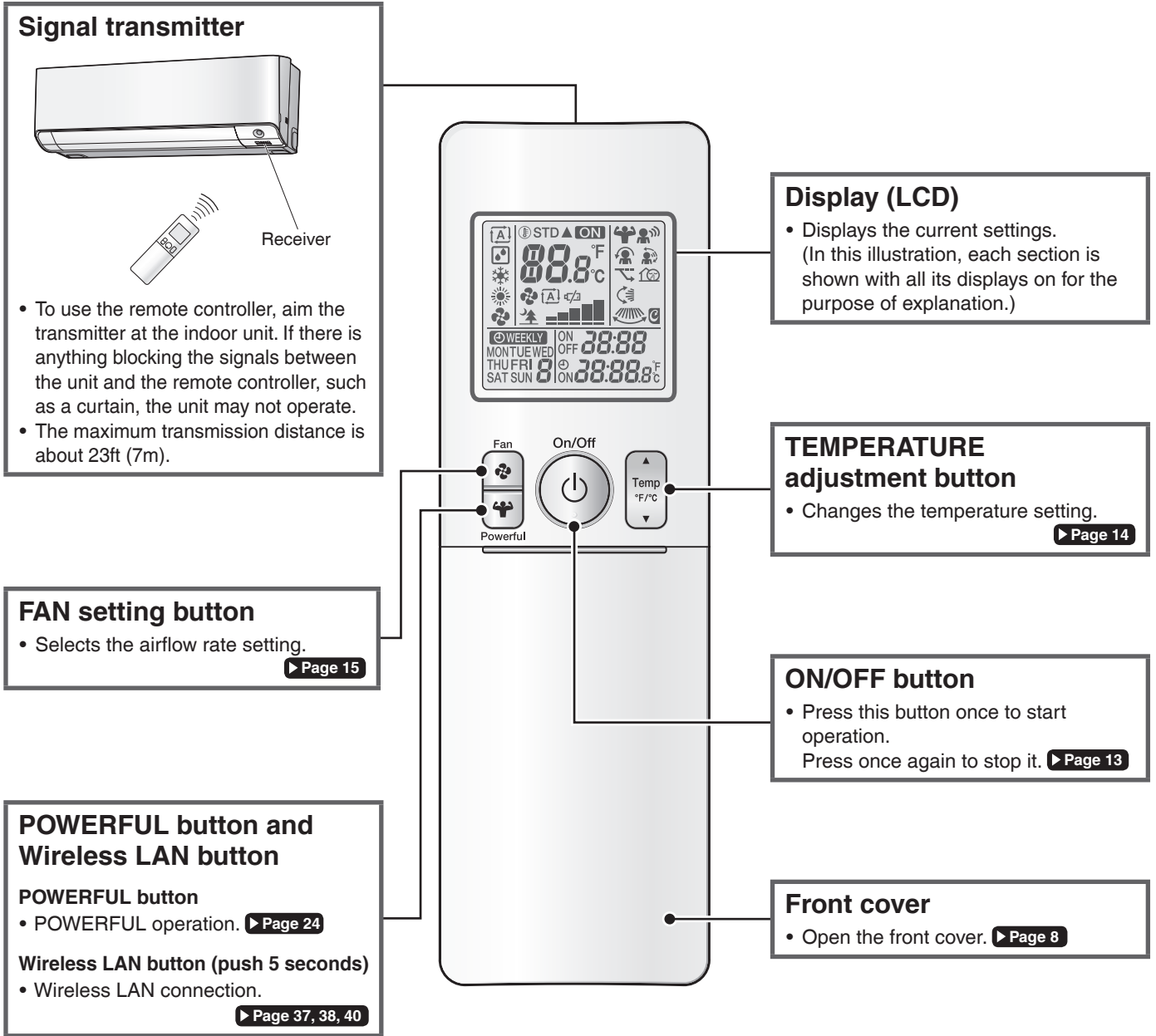

FTXM09WVJU9	ARC466A70
FTXM12WVJU9	
FTXM18WVJU9	ARC466A71
FTXM24WVJU9	

■ Open the front cover

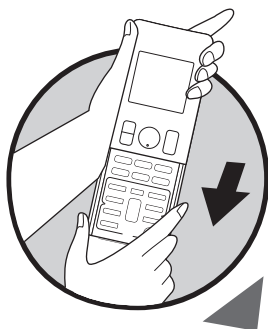

MODE selector button

- Selects the operation mode. (AUTO/DRY/COOL/HEAT/FAN)

▶ Page 13

ECONO/QUIET button

- ECONO/QUIET OUTDOOR UNIT operation. ▶ Page 25

SENSOR button

- INTELLIGENT EYE operation.

FTXM09WVJU9 / FTXM12WVJU9



▶ Page 19

FTXM18WVJU9 / FTXM24WVJU9



▶ Page 21

COMFORT button

- COMFORT AIRFLOW operation.

▶ Page 23

OFF TIMER button (NIGHT SET mode)

▶ Page 27

TIMER CANCEL button

- Cancels the timer setting.
- Cannot be used for the WEEKLY TIMER operation.

▶ Page 26, 27

SELECT button

- Changes the clock, ON/OFF TIMER and WEEKLY TIMER settings.

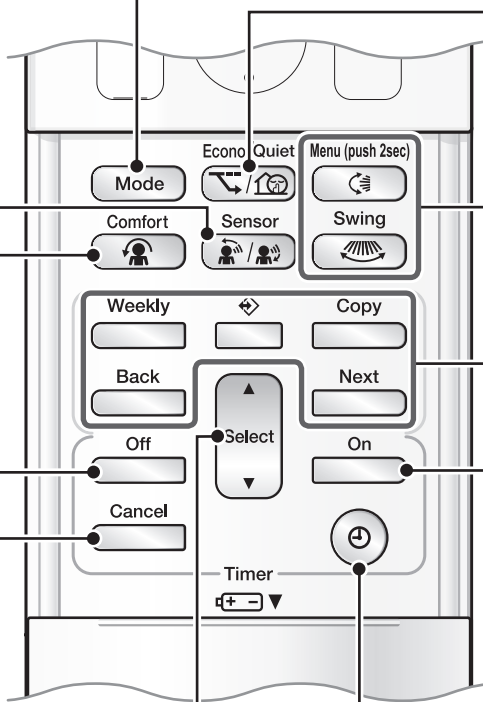

SWING button and MENU button

- SWING button**
- Adjusts the airflow direction. ▶ Page 16

- MENU button (push 2 seconds)**
- Adjusts the display brightness. ▶ Page 12
 - CLEAN operation. ▶ Page 17, 18

- Weekly
- [Button] : WEEKLY button
 - [Button] : PROGRAM button
 - Copy
 - [Button] : COPY button
 - Back
 - [Button] : BACK button
 - Next
 - [Button] : NEXT button
 - WEEKLY TIMER operation. ▶ Page 29

ON TIMER button

▶ Page 26

CLOCK button

▶ Page 11

Names of Parts

Wireless LAN connection adapter

The Wireless LAN connection adapter function requires the Daikin Comfort Control App for connecting to the air conditioner and controlling it via your smartphone or tablet over your network.

Attention

- **Wireless LAN sends and receives data using radio waves so there is a risk of transmitted data being subject to eavesdropping and illegal access. When using wireless LAN, manage the SSID/KEY of the wireless LAN connection adapter, the SSID/KEY of the wireless router, and the app login information so that they will not be known to others, and ensure that you have an adequate understanding of the risks involved.** ▶ Page 6
In the case that the product is accessed and operated illegally, turn off the wireless LAN connection adapter function. ▶ Page 40
- **Do not use this product near a microwave oven. (This can affect wireless LAN communications.)**
- **This product cannot be directly connected to the communication line of a telecommunications carrier (internet service provider, etc.). When connecting to the internet, be sure to connect via a device such as a router.**
 When the wireless LAN connection adapter function is turned on, the right side of the air conditioner may become slightly warm, but this is not an abnormality.

[About the SSID and KEY]

- The [SSID] and [KEY] shown on the serial number sticker are necessary when connecting the air conditioner to a smartphone via wireless LAN.

! WARNING

- While the Wireless LAN connection adapter operates, it may affect persons using cardiac pacemakers or defibrillators. This product may cause electromagnetic interference.
- While the Wireless LAN connection adapter operates, it may affect automatic doors or fire alarm equipment. This product may cause faulty behavior of the equipment.

Configuration

- The user is responsible for providing the following items before using this product:
 - Smartphone or tablet PC
 - Internet line and communicating device (Modem/router or similar device)
 - Wireless LAN access point
 - Application name: [Daikin Comfort Control App] (free)
 For details on the installation method for the Daikin Comfort Control App, please see ▶ Page 35.

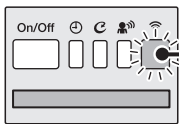

Display

Wireless LAN connection adapter lamp (Orange)

- The Wireless LAN connection adapter lamp lights when connecting to a router (Wireless LAN access point). Please see ▶ Page 35.
- For Wireless LAN connection adapter operation, please see ▶ Page 40.

! WARNING

When operating an air conditioner from outside the home, it is not possible to check the air conditioner or the surroundings of the air conditioner, or the state of the people in the room. Therefore, make sure to adequately check for safety before use. In some cases, there is a risk of death, severe injury, or property damage.

■ Check the following in advance (while at home)

- Timer settings or reservations that other users may have made. (There is a risk of causing harm to the health of people, animals, or plants in the home if operation starts and stops unexpectedly)
- There are no signs of abnormality in the air conditioning. Harm will not be caused to people or to the room if there is a change in airflow. (For example, that there are no objects nearby that might blow over) (There is a risk of objects falling due to airflow and causing fire, bodily injury, or staining of household items)

■ Check the following before/while operating a unit from outside the home

- If you know that there is someone at home, inform the person when turning the air conditioner on or off from outside the home. (If someone at home is standing on something such as a stool, the air conditioner turning on or off unexpectedly could surprise them and cause them to fall or topple over. Additionally, a sudden change in the indoor/outdoor temperature could harm the health of people at home)
 - The air conditioner can be turned off and temperature adjustment can be made using a remote controller in the home.
 - Do not use the function if the only people at home are persons who are unable to make adjustments to temperature or other settings themselves, such as young children, disabled persons, or elderly persons.
- Regularly check the settings and operating status of the air conditioner. (Sudden changes in indoor/outdoor temperature pose a health hazard. There is a risk of harm to animals and plants)
 If an error occurs during operation, immediately turn off the air conditioner and contact your dealer.
 Double check the display to confirm that the power is off.

Preparation Before Operation

CAUTION

Incorrect handling of batteries can result in injury from battery leakage, rupturing or heating, or lead to equipment failure.

Please observe the following precautions and use safely.

- If the alkaline solution from the batteries should get in the eyes, do not rub the eyes. Instead, immediately flush the eyes with tap water and seek the attention of a medical professional.
- Keep batteries out of reach of children. In the event that batteries are swallowed, seek the immediate attention of a medical professional.
- Do not expose batteries to heat or fire. Do not disassemble or modify batteries. The insulation or gas release vent inside the battery may be damaged, resulting in battery leakage, rupturing, or heating.
- Do not damage or peel off labels on the batteries.

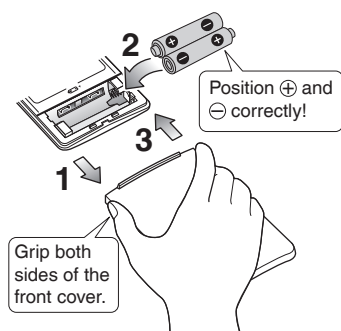

To insert the batteries



1. Slide the front cover to take it off.
2. Insert 2 dry batteries AAA.LR03 (alkaline).
3. Replace the front cover.

To attach the remote controller holder to a wall

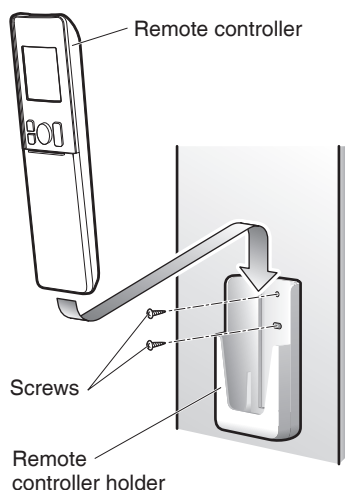
1. Choose a place where the signals reach the unit.
2. Attach the holder to a wall, a pillar, or similar location with the screws supplied with the holder.
3. Place the remote controller in the remote controller holder.



Fahrenheit/Celsius display switch

Press  and  (TIMER button) simultaneously for about 5 seconds.

- The temperature will be displayed in Celsius when it is presently displayed in Fahrenheit, and vice versa.
- The switch operation is only possible when the temperature is being displayed.
- A reception sound will go off for the transmission of set temperature to the indoor unit at the time of setting the Fahrenheit/Celsius display change function.

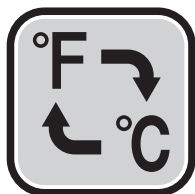

NOTE

Notes on batteries

- To avoid possible injury or damage from battery leakage or rupturing, remove the batteries when not using the product for long periods of time.
- The standard replacement time is about 1 year. Both batteries should be replaced at the same time. Be sure to replace them with new dry batteries AAA.LR03 (alkaline).
- When battery power has run out, "battery mark" will begin blinking on the LCD as an alert that the batteries need replacing. In some cases, when battery consumption is accelerated due to usage conditions, signal reception may decline before the LCD begins blinking.
- The batteries supplied with the remote controller are for initial operation. The batteries may run out in less than 1 year.

Notes on remote controller

- Do not drop the remote controller. Do not get it wet.
- If dirt becomes an issue, wipe with a soft dry cloth.

Preparation Before Operation



Turn on the circuit breaker

- After the power is turned on, the flaps of the indoor unit open and close once to set the reference position.

To set the clock

1. Press .



“0:00” is displayed on the LCD.
“MON” and “” blink.

2. Press  **to set the current day of the week.**

Display	Day of the week
MON	Monday
TUE	Tuesday
WED	Wednesday
THU	Thursday
FRI	Friday
SAT	Saturday
SUN	Sunday

3. Press .



“” blinks.

4. Press  **to set the clock to the present time.**

- Holding down  or  rapidly increases or decreases the displayed time.

5. Press .

- Point the remote controller at the indoor unit when pressing the buttons.



“.” blinks.

NOTE

Note on setting the clock

- If the indoor unit's internal clock is not set to the correct time, the ON/OFF TIMER and WEEKLY TIMER will not operate punctually.

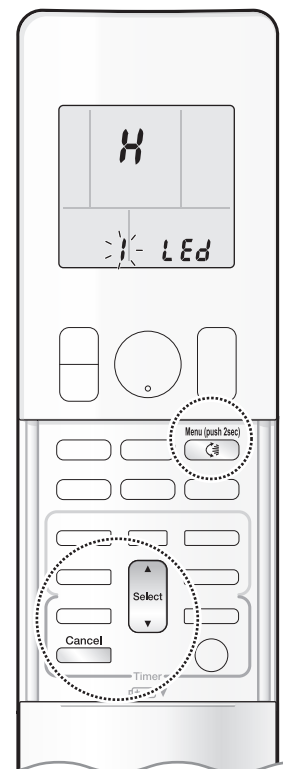

To set the brightness of the indoor unit lamps

Adjust the brightness of the indoor unit display as desired, or turn OFF the display.

To set

1. Press  and hold the button for 2 seconds.

2. Press  or  and select menu number **1**.

- “LED” appears on the LCD.
- “1” blinks.

3. Press  to confirm the selected setting.

4. Press  or  to change the setting as follows:

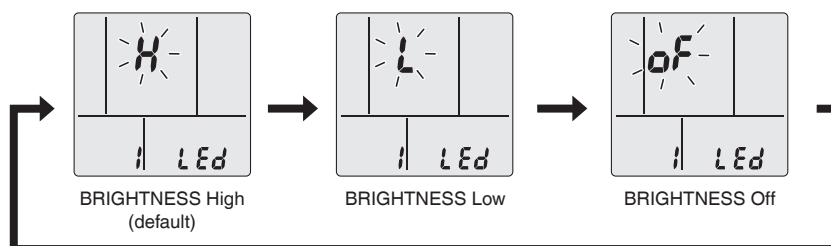

5. Press  again.

- Brightness will be set to the chosen value.

6. Press  to return to the default screen.

NOTE

Note on setting brightness of the indoor unit lamps

- The display automatically returns to the default screen after 60 seconds. To return to the default screen sooner, press  twice.



AUTO · DRY · COOL · HEAT · FAN Operation

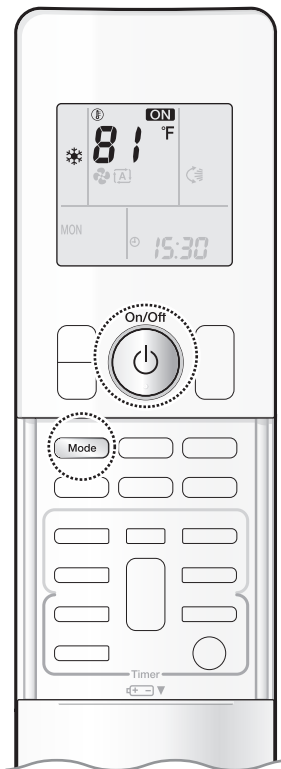

The air conditioner operates with the operation mode of your choice. From the next time on, the air conditioner will operate with the same operation mode.

To start operation

1. Press **Mode** and select an operation mode.

- Each pressing of the button changes the mode setting in sequence.

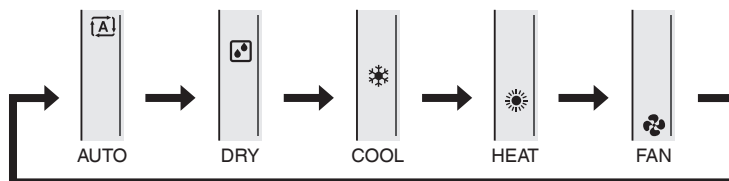

2. Press **On/Off**.

- “**ON**” is displayed on the LCD.
- The OPERATION lamp lights green.

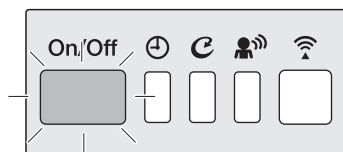

Display

To stop operation

Press **On/Off** again.

- “**ON**” disappears from the LCD.
- The OPERATION lamp goes off.

NOTE

Notes on AUTO operation

- In AUTO operation, the system selects an appropriate operation mode (COOL or HEAT) based on the indoor temperature and starts the operation.
- The system automatically reselects setting at a regular interval to bring the indoor temperature to the user-setting level.

Note on DRY operation

- Eliminates humidity while maintaining the indoor temperature as much as possible. It automatically controls temperature and airflow rate, so manual adjustment of these functions is unavailable.

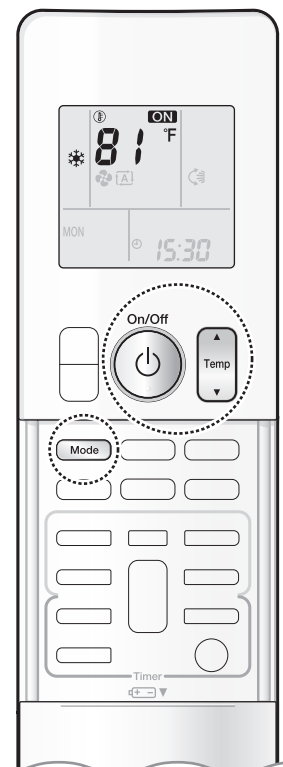

To change the temperature setting

Press .

- Press ▲ to raise the temperature and press ▼ to lower the temperature. Each pressing of the button changes the temperature by 1°F (0.5°C).

COOL operation	HEAT operation	AUTO operation	DRY operation	FAN operation
64-90°F (18.0-32.0°C)	50-86°F (10.0-30.0°C)	64-86°F (18.0-30.0°C)	"STD~(STD-5°F)" *1,*2 ("STD~(STD-3.0°C)")	The temperature setting cannot be changed.

*1 STD (Standard)... Indoor temperature at the time when the DRY operation is started.

*2 STD (Standard)... " , STD " is displayed on the LCD.

Dry (Dehumidifying)

To use Dry (Dehumidifying) mode

Press and select DRY operation mode.

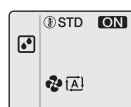

- " ", " STD " is displayed on the LCD.
- DRY operation starts.

- Press to raise the temperature and press to lower the temperature by 1°F (0.5°C) with each press.

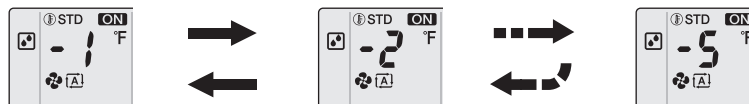

- This mode mixes dehumidified cool air with room air to adjust the air outlet temperature and remove moisture.
- When the indoor temperature rises, COOL operation automatically starts.
- When the outdoor temperature is lower than the indoor temperature, dehumidifying is less effective.

NOTE

Note on changing the temperature setting

- In order to lower the humidity, the airflow rate during the DRY operation is automatically controlled.

Tips for saving energy

Keeping the temperature setting at a moderate level helps save energy.

- Recommended temperature setting
 - For cooling: 78-82°F (26.0-28.0°C)
 - For heating: 68-75°F (20.0-24.0°C)

Cover windows with a blind or a curtain.

- Blocking sunlight and air from outdoors increases the cooling (heating) effect.

Keep the air filters clean.

- Clogged air filters cause inefficient operation and waste energy. Clean them once in about every 2 weeks. [▶ Page 42](#)

If you are not going to use the air conditioner for a long period, for example in spring or autumn, turn off the circuit breaker.

- The air conditioner always consumes a small amount of electricity even while it is not operating.





Adjusting the Airflow Rate

You can adjust the airflow rate to increase your comfort.

To adjust the airflow rate setting

Press .

- Each pressing of changes the airflow rate setting in sequence.

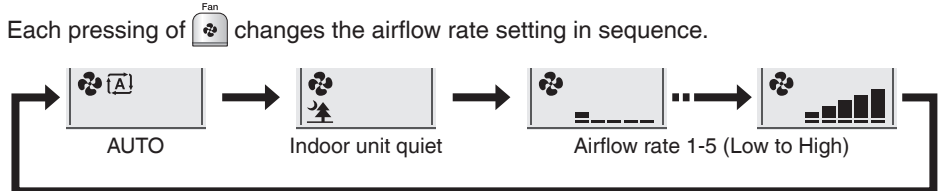

- When the airflow is set to “”, quiet operation starts and noise from the indoor unit will become quieter.
- In the quiet operation mode, the airflow rate is set to a weak level.

AUTO, COOL, HEAT and FAN operation			DRY operation
			The airflow rate setting cannot be changed.

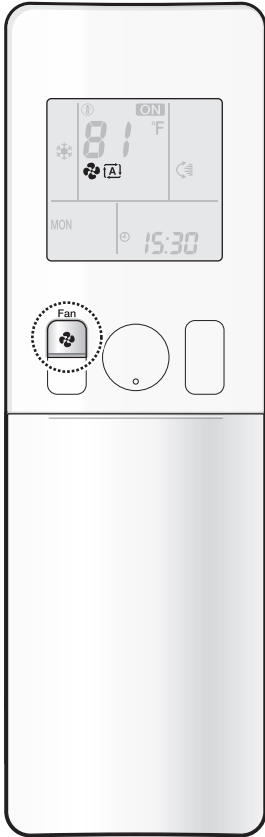

NOTE

Note on airflow rate setting

- At smaller airflow rates, the cooling (heating) effect is also smaller.

Note on AUTO airflow rate

- When using AUTO airflow rate, the airflow rate is adjusted according to conditions in the room. Depending on the conditions in the room, the airflow rate may become weaker than during the quiet operation mode.



Adjusting the Airflow Direction

You can adjust the airflow direction to increase your comfort.

⚠ CAUTION

- Always use a remote controller to adjust the angles of the flaps and louvers.
 - If you attempt to move the flaps and louvers forcibly by hand when they are swinging, the mechanism may be damaged.
 - Inside the air outlet, a fan is rotating at a high speed.

To start auto swing

Up and down airflow direction

Press .

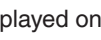
- “” is displayed on the LCD.
- The flaps (horizontal blades) will begin to swing.

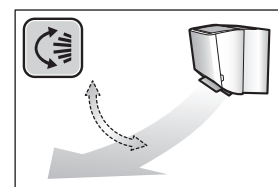

Right and left airflow direction

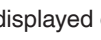

Press .

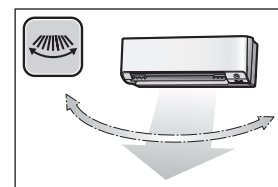
- “” is displayed on the LCD.
- The louvers (vertical blades) will begin to swing.

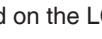
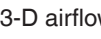

The 3-D airflow direction

Press  and .

- “” and “” are displayed on the LCD.
- The flaps and louvers move in turn.
- To cancel 3-D airflow, press either  or  again. The flaps or louvers will stop moving.

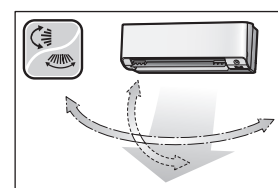

To set the flaps or louvers at the desired position

- This function is effective while the flaps or louvers are in auto swing mode.

Press  and  when the flaps or louvers reach the desired position.

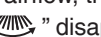
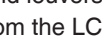
- In the 3-D airflow, the flaps and louvers move in turn.
- “” or “” disappears from the LCD.

NOTE

Notes on airflow direction setting

- The movable range of the flaps varies according to the operation mode.
- If the airflow rate becomes weak during operation, the flaps and louvers will stop. When up and down airflow direction is set, the flaps will stop in an upward position.
- When the airflow rate setting is low, or when 3-D airflow direction is set, the room temperature may not reach the set temperature (for example, if the air conditioner is blowing air toward the wall). In that case, change the airflow direction or the airflow rate.

Note on 3-D airflow

- Using 3-D airflow circulates cold air, which tends to be collected at the bottom of the room, and hot air, which tends to collect near the ceiling, throughout the room, preventing areas of cold and hot developing.

Movable range of the flaps

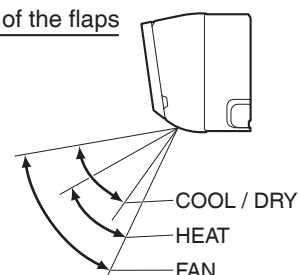

CLEAN Operation

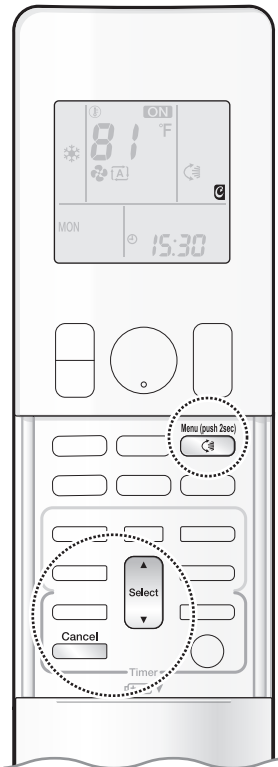

The CLEAN function dries the interior of the indoor unit to reduce the amount of condensation present. When COOL or DRY operation is performed, condensation may occur inside the air conditioner. It is recommended to dry the inside of the air conditioner using CLEAN operation.

[To operate automatically]

To set

1. Press  **and hold the button for 2 seconds.**

2. Press  **or**  **and select menu number 2.**

- “” appears on the LCD.
- “2” blinks.

3. Press  **to confirm the selected setting.**

4. Press  **or**  **to change the setting as follows:**

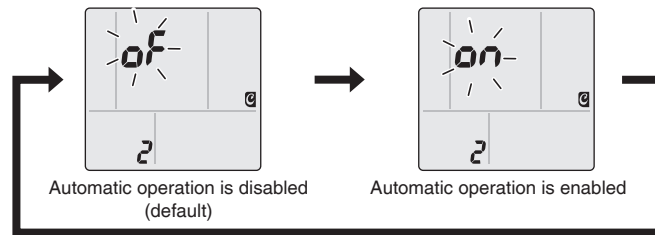

5. Press  **again.**

- Automatic CLEAN operation will be enabled or disabled according to the chosen setting.
- If automatic CLEAN operation is enabled, “” appears on the LCD and the CLEAN lamp lights green when CLEAN operation is in progress.

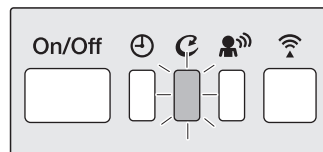

Display

6. Press  **to return to the default screen.**

NOTE

Note on CLEAN setting

- The display automatically returns to the default screen after 60 seconds. To return to the default screen sooner, press  twice.

Notes on CLEAN operation

- When you want to stop CLEAN operation midway, press  twice.
- After DRY or COOL operation stops, the air conditioner starts CLEAN operation automatically, and then stops automatically 140 minutes later.
- This operation dries the inside of the air conditioner using FAN operation and HEAT operation. The indoor temperature and humidity may not suit your preferences.
- The CLEAN function dries the interior of the indoor unit to reduce the amount of condensation present.
- CLEAN operation is not available when the unit is turned off using the OFF TIMER or turned off using a smartphone.

NOTE

Notes on CLEAN operation

- The flaps may sometimes close to increase the drying effect inside the air conditioner.
- CLEAN operation automatically dries the inside of the air conditioner each time after COOL and DRY operation is stopped.
- CLEAN operation may not be performed if the COOL or DRY operation time is short.
- If CLEAN operation does not suit your preference, set operation to "Off". ▶ **Page 17**

Relation between CLEAN operation and indoor unit lamps

Air conditioner	LCD	CLEAN lamp
Operating (OPERATION lamp lights up)	CLEAN is "ON"	Lights up
	CLEAN is "OFF"	Goes off
Not operating (OPERATION lamp goes off)	CLEAN is "ON"	Goes off
	CLEAN is "OFF"	Lights up (Clean is "Operating")
	CLEAN is "OFF"	Goes off



2-AREA INTELLIGENT EYE Operation

FTXM09WVJU9 / FTXM12WVJU9

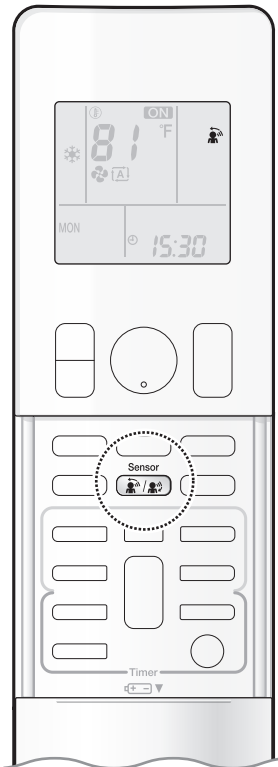

The INTELLIGENT EYE sensor detects human movement and adjusts airflow direction. It can be set to avoid people or to direct airflow specifically at people. If no one is in the room for more than 20 minutes, the operation automatically changes to energy saving operation.

⚠ CAUTION

- Do not place large objects near the INTELLIGENT EYE sensor. Also keep heating units and humidifiers outside the sensor's detection area. This sensor can detect undesirable objects.
- Do not hit or violently push the INTELLIGENT EYE sensor. This can lead to damage and malfunction.

To start INTELLIGENT EYE operation

▶ Press  and select the desired mode.

- Each time  is pressed, a different setting option appears on the LCD.
- When INTELLIGENT EYE is selected, the INTELLIGENT EYE lamp lights green.

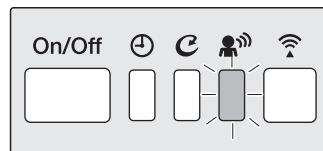

Display



- When the flaps (horizontal blades) is swinging, selecting any of the modes above will cause the flaps (horizontal blades) to stop.

To cancel INTELLIGENT EYE operation

▶ Press  until no icon is displayed.

NOTE



Notes on combining INTELLIGENT EYE operation and COMFORT AIRFLOW operation

- INTELLIGENT EYE operation can operate in combination with COMFORT AIRFLOW operation.
When the INTELLIGENT EYE operation is set to blow directly on people and COMFORT AIRFLOW operation is activated simultaneously, the air conditioner tracks you horizontally, without the air blowing directly on you.
- The airflow rate will be set to AUTO. If the up and down airflow direction is selected, the COMFORT AIRFLOW operation will be canceled. Priority is given to the function of whichever button is pressed last.

How INTELLIGENT EYE operation works

The INTELLIGENT EYE sensor detects human movement and adjusts the right and left airflow direction. If no one is in the room for more than 20 minutes, the operation automatically changes to energy saving operation. The INTELLIGENT EYE sensor works differently depending on the situation.

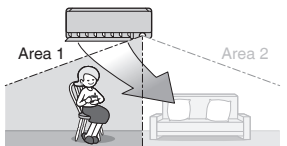
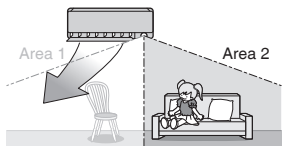
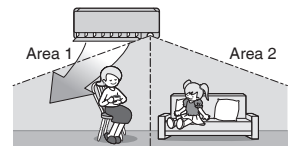
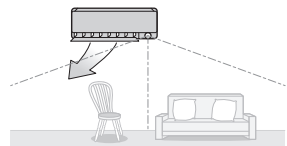
[Example]

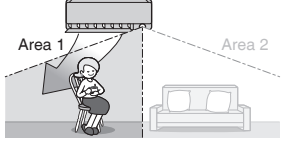
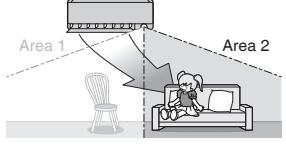
	A person is detected in area 1.	A person is detected in area 2.	People are detected in both areas.	No people are detected in the areas.
				
			When INTELLIGENT EYE operation is used, the unit will not blow air directly at people (only in their general direction).	The air conditioner will switch to energy-saving mode after 20 minutes.

* The airflow direction may differ from the illustrated direction depending on the actions and movements of the people in the areas.

INTELLIGENT EYE operation is useful for energy saving

Energy saving operation

- If no presence detected in the room for 20 minutes, the energy saving operation will start, and the INTELLIGENT EYE lamp goes off. If human movement is detected again, the INTELLIGENT EYE lamp lights up and energy saving operation terminates.
- This operation changes the temperature by -3.6°F (-2.0°C) in HEAT / $+3.6^{\circ}\text{F}$ ($+2.0^{\circ}\text{C}$) in COOL / $+3.6^{\circ}\text{F}$ ($+2.0^{\circ}\text{C}$) in DRY operation from the set temperature.
 - When the room temperature exceeds 86°F (30.0°C), the operation changes the temperature by $+1.8^{\circ}\text{F}$ ($+1.0^{\circ}\text{C}$) in COOL / $+1.8^{\circ}\text{F}$ ($+1.0^{\circ}\text{C}$) in DRY operation from the set temperature.
- This operation decreases the airflow rate slightly in FAN operation only.

NOTE

Notes on INTELLIGENT EYE operation

- Application range is as follows.

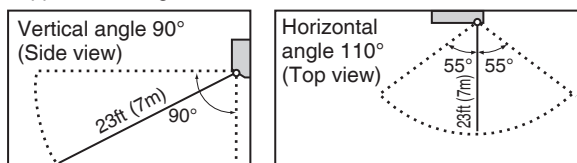

- If the air conditioner is in INTELLIGENT EYE operation and the mode "Do not blow directly on people" is selected, the louvers adjust the airflow direction if there are people in the sensing areas of the INTELLIGENT EYE so that the leftward or rightward airflow will not be directed to the people. If no people are detected in either area 1 or 2 for 20 minutes, the air conditioner switches to the energy-saving mode with the set temperature shifted by 3.6°F (2.0°C).
 - The air conditioner may switch to the energy-saving operation even if there are people in the areas. This may occur depending on the clothes the people are wearing, if there is no movement of the people in the areas.
- The airflow direction from the louvers will be leftward if there are people in both areas 1 and 2. The air will also flow left if there is a person right in front of the sensor as the sensor judges that there are people in both areas.
- Due to the position of the sensor, people might be exposed to the airflow of the indoor unit if they are close to the front side of the indoor unit. If there are people close to the front side of the indoor unit or in both areas, it is recommended to use the COMFORT AIRFLOW and INTELLIGENT EYE operations simultaneously. Using both modes together, the air conditioner will not direct the airflow towards the people.
- The sensor could also mistakenly detect pets, sunlight, fluttering curtains and light reflected off of mirrors as passers-by.
- The sensor may not detect moving objects further than 23ft (7m) away. (Please see the application range)
- Sensor detection sensitivity changes according to the indoor unit location, the speed of passers-by, temperature range, etc.
- NIGHT SET mode  Page 27 will not switch on during use of INTELLIGENT EYE operation.



INTELLIGENT EYE Operation

FTXM18WVJU9 / FTXM24WVJU9

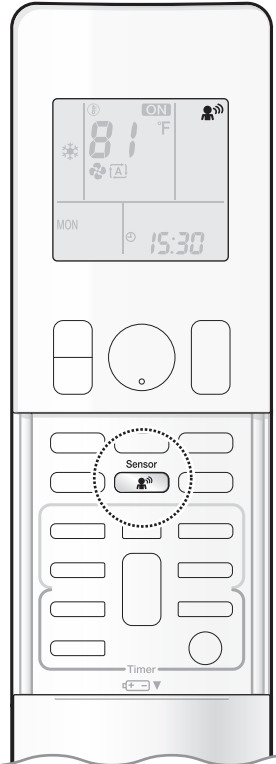

The INTELLIGENT EYE operation detects human movement. If no one is detected in the room for more than 20 minutes, the unit automatically enters energy saving operation.

⚠ CAUTION

- Do not place large objects near the INTELLIGENT EYE sensor. Also keep heating units and humidifiers outside the sensor's detection area. This sensor can detect undesirable objects.
- Do not hit or violently push the INTELLIGENT EYE sensor. This can lead to damage and malfunction.

To start INTELLIGENT EYE operation

▶ Press  and select the desired mode.

- Each time  is pressed, a different setting option is displayed on the LCD.
- The INTELLIGENT EYE lamp lights green.

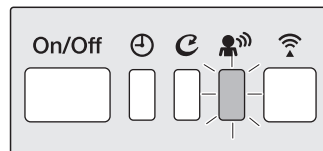

Display

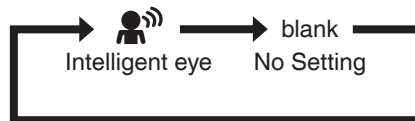

To cancel INTELLIGENT EYE operation

▶ Press  button.

- The INTELLIGENT EYE lamp goes off.

INTELLIGENT EYE operation is useful for energy saving

■ People are detected in the sensing area.

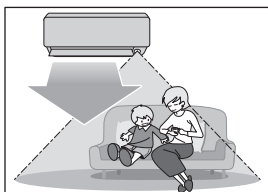

The air conditioner is in normal operation while the sensor is detecting human movement.

■ No people are detected in the sensing area.

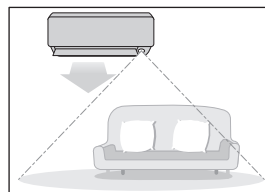

The air conditioner will switch to energy-saving mode after 20 minutes.

Energy saving operation

- If no presence detected in the room for 20 minutes, the energy saving operation will start, and the INTELLIGENT EYE lamp goes off. If human movement is detected again, the INTELLIGENT EYE lamp lights up and energy saving operation terminates.
- This operation changes the temperature by -3.6°F (-2.0°C) in HEAT / $+3.6^{\circ}\text{F}$ ($+2.0^{\circ}\text{C}$) in COOL / $+3.6^{\circ}\text{F}$ ($+2.0^{\circ}\text{C}$) in DRY operation from the set temperature.
When the room temperature exceeds 86°F (30.0°C), the operation changes the temperature by $+1.8^{\circ}\text{F}$ ($+1.0^{\circ}\text{C}$) in COOL / $+1.8^{\circ}\text{F}$ ($+1.0^{\circ}\text{C}$) in DRY operation from the set temperature.
- This operation decreases the airflow rate slightly in FAN operation only.

NOTE

Notes on INTELLIGENT EYE operation

- Application range is as follows.

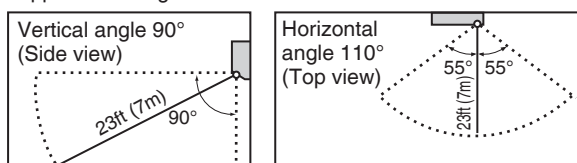

- The air conditioner may switch to the energy-saving operation even if there are people in the areas.
This may occur depending on the clothes the people are wearing, if there is no movement of the people in the areas.
- The sensor could also mistakenly detect pets, sunlight, fluttering curtains and light reflected off of mirrors as passers-by.
- The sensor may not detect moving objects further than 23ft (7m) away. (Please see the application range)
- Sensor detection sensitivity changes according to the indoor unit location, the speed of passers-by, temperature range, etc.
- NIGHT SET mode [▶ Page 27](#) will not switch on during use of INTELLIGENT EYE operation.



COMFORT AIRFLOW Operation

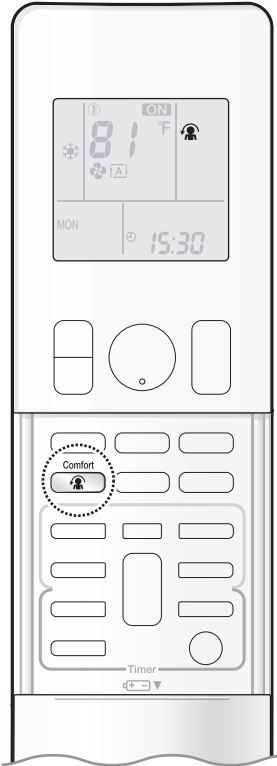

The flow of air will be in the upward direction while in COOL and DRY operation and in the downward direction while in HEAT operation, which will provide a comfortable airflow that will not come in direct contact with people.

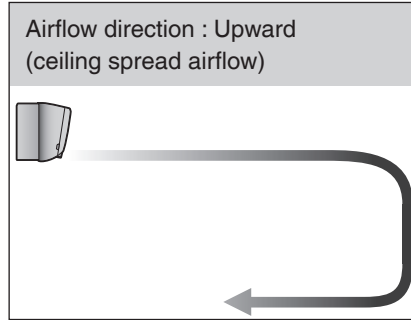

COOL and DRY operation

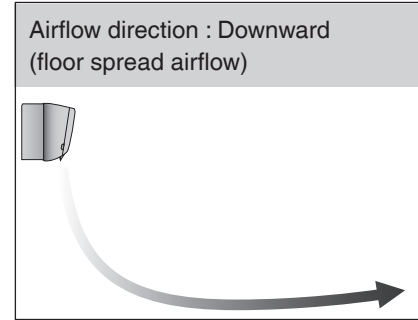

HEAT operation

To start COMFORT AIRFLOW operation

Press  .

- “” appears on the LCD.

	COOL and DRY operation	HEAT operation	FAN operation
Flaps direction	Goes up	Goes down	Not available
Airflow rate	AUTO		

To cancel COMFORT AIRFLOW operation

Press  again.

- “” disappears from the LCD.
- The flaps will return to the memory position from before COMFORT AIRFLOW operation.

NOTE

Notes on COMFORT AIRFLOW Operation

- The airflow rate will be set to AUTO.
- If the upward and downward airflow direction is selected, the COMFORT AIRFLOW function will be canceled. Priority is given to the function of whichever button is pressed last.



POWERFUL Operation

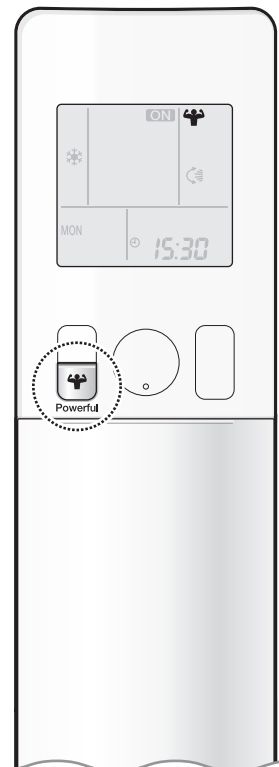

POWERFUL operation quickly maximizes the cooling (heating) effect in any operation mode. In this mode, the air conditioner operates at maximum capacity.

To start POWERFUL operation

Press  during operation.

- “” is displayed on the LCD.
- POWERFUL operation ends in 20 minutes. Then the system automatically operates again with the previous settings which were used before POWERFUL operation.



To cancel POWERFUL operation

Press  again.

- “” disappears from the LCD.

NOTE

Notes on POWERFUL operation

- Pressing  causes the settings to be canceled, and “” disappears from the LCD.
- POWERFUL operation will not increase the capacity of the air conditioner if the air conditioner is already in operation with its maximum capacity demonstrated.
 - In **COOL, HEAT and AUTO operation**
To maximize the cooling (heating) effect, the capacity of outdoor unit increases and the airflow rate becomes fixed at the maximum setting. The temperature and airflow settings cannot be changed in COOL and HEAT operation. Airflow settings cannot be changed in AUTO operation.
 - In **DRY operation**
The temperature setting is lowered by 4.5°F (2.5°C) and the airflow rate is slightly increased.
 - In **FAN operation**
The airflow rate is fixed at the maximum setting.

Regarding the combination of POWERFUL and other operations

POWERFUL + COMFORT AIRFLOW	Not available*
POWERFUL + ECONO	
POWERFUL + QUIET OUTDOOR UNIT	

*Priority is given to the function of whichever button is pressed last.



ECONO / QUIET OUTDOOR UNIT Operation

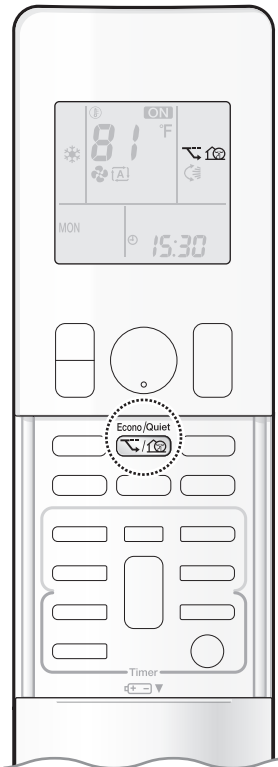

ECONO operation enables efficient operation by limiting the maximum power consumption.

This function is useful to prevent the circuit breaker from tripping when the unit operates alongside other appliances on the same circuit.

QUIET OUTDOOR UNIT operation lowers the noise level of the outdoor unit by changing the frequency and fan speed of the outdoor unit. This function is convenient during the night-time operation.

To start operation

Press  and select the desired mode.

- Each time  is pressed, a different setting option is displayed on the LCD.





To cancel operation

Press  until no icon is displayed.

NOTE

Notes on ECONO operation

- This operation is performed with lower power and therefore may not provide a sufficient cooling (heating) effect.
- Pressing  causes the settings to be canceled, and “” disappears from the LCD.
- If the power consumption level is already low, switching to ECONO operation will not reduce the power consumption.

Notes on QUIET OUTDOOR UNIT operation

- Even if the operation is stopped by using the remote controller or the indoor unit ON/OFF switch when using QUIET OUTDOOR UNIT operation, “” will remain displayed on the remote controller.
- QUIET OUTDOOR UNIT operation will not reduce the frequency nor fan speed if they already are operating at reduced levels.
- This operation is performed with lower power and therefore may not provide a sufficient cooling (heating) effect.

Possible combinations of ECONO / QUIET OUTDOOR UNIT operation and basic operations

	Operation mode				
	AUTO	DRY	COOL	HEAT	FAN
ECONO	✓	✓	✓	✓	–
QUIET OUTDOOR UNIT	✓	–	✓	✓	–



ON/OFF TIMER Operation



Timer functions are useful for automatically switching the air conditioner on or off in the morning or at night. You can also use the ON TIMER and OFF TIMER together.

To use ON TIMER with a 24 hour clock display (24 HOUR ON/OFF TIMER)

- Check that the clock is correct.
If not, set the clock to the present time. ▶ [Page 11](#)

1. Press .

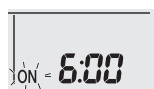

“6:00” is displayed on the LCD.
“ON” blinks.

- “⌚” and day of the week disappear from the LCD.

2. Press until the time setting reaches the point you like.

- Each pressing of either button increases or decreases the time setting by 10 minutes.
Holding down either button changes the setting rapidly.

3. Press again.

- “ON” and setting time are displayed on the LCD.
- The TIMER lamp lights orange. ▶ [Page 5](#)

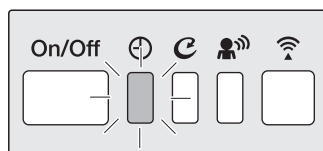

Display

To cancel ON TIMER operation

Press .

- “ON” and setting time disappear from the LCD.
- “⌚” and day of the week are displayed on the LCD.
- The TIMER lamp goes off.

NOTE

Notes on TIMER operation

- When TIMER is set, the present time is not displayed.
- When using the ON/OFF TIMER to start/stop operation, the actual operation start/stop time may differ from the time set. (Maximum of about 10 minutes)
- The ON/OFF TIMER remembers the time set previously.
- The ON TIMER will begin operation in the settings used previously for operation mode, temperature, airflow rate, and airflow direction.

In the following cases, set the timer again.

- After the circuit breaker has turned off.
- After a power failure.
- After replacing the batteries in the remote controller.



ON/OFF TIMER Operation

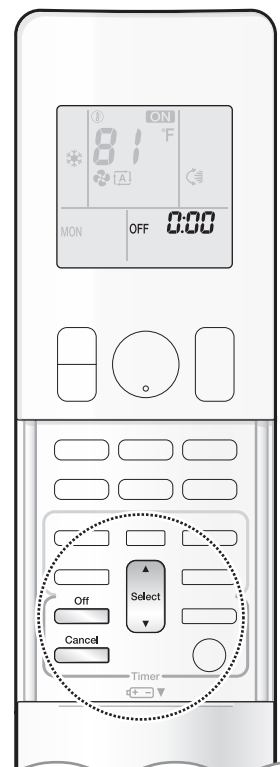

To use OFF TIMER with a 24 hour clock display (24 HOUR ON/OFF TIMER)

- Check that the clock is correct.
If not, set the clock to the present time. ▶ Page 11

1. Press .



“ 0:00 ” is displayed on the LCD.
“ OFF ” blinks.

- “ ⌚ ” and day of the week disappear from the LCD.

2. Press until the time setting reaches the point you like.

- Each pressing of either button increases or decreases the time setting by 10 minutes.
Holding down either button changes the time setting rapidly.

3. Press again.

- “ OFF ” and setting time are displayed on the LCD.
- The TIMER lamp lights orange. ▶ Page 5

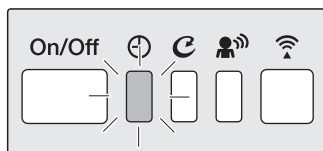

Display

To cancel OFF TIMER operation

Press .

- “ OFF ” and setting time disappear from the LCD.
- “ ⌚ ” and day of the week are displayed on the LCD.
- The TIMER lamp goes off.

To combine ON TIMER and OFF TIMER operation

- A sample setting for combining the 2 timers is shown below.

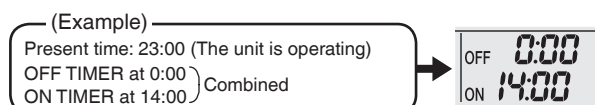

NOTE

NIGHT SET mode

- When the OFF TIMER is set, the air conditioner automatically adjusts the temperature setting (0.9°F (0.5°C) up in COOL, 3.6°F (2.0°C) down in HEAT) to prevent excessive cooling (heating) during sleeping hours.

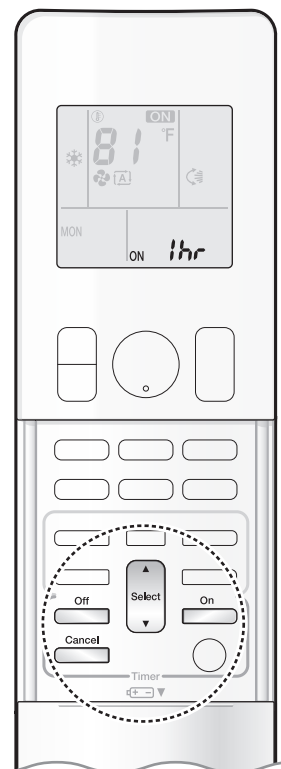

To use the ON/OFF TIMER with an hours remaining display (COUNT UP-DOWN ON/OFF TIMER)

- Check that the clock is correct. If not, set the clock to the present time. ▶ Page 11

1. Press and hold or for about 5 seconds, when the signal indicator (▲) blinks, release your finger from the button.

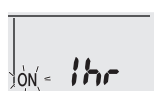
For ON TIMER
 "1hr" appears on the LCD.
 "ON" blinks.

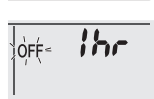
For OFF TIMER
 "1hr" appears on the LCD.
 "OFF" blinks.

- "⌚" and day of the week disappear from the LCD.

2. Press until the time setting reaches the point you like.

- Each pressing of the button increases or decreases the time setting by 1 hour.
- The time can be set between 1 and 12 hours.

3. Press or again.

- "ON" and "OFF", and setting time appear on the LCD.
- The TIMER lamp lights orange.
- To change the display mode from COUNT UP-DOWN ON/OFF TIMER to 24 HOUR ON/OFF TIMER, repeat **STEP 1**, and continue from **STEP 2** of "24 HOUR ON/OFF TIMER". ▶ Page 26, 27
- Timer display mode cannot be changed while "ON" or "OFF" are blinking.
 Press or to stop the blinking.

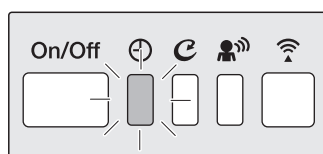

Display

Combining display modes

- Different display modes (24 HOUR ON/OFF TIMER and COUNT UP-DOWN ON/OFF TIMER) can be used for the ON TIMER and OFF TIMER simultaneously.

(Example)

Present time: 22:00 [unit is operating]
 OFF TIMER at 1:00 (3 hours after present time)
 ON TIMER at 6:00 (8 hours after present time)) Combined



NOTE

Note on COUNT UP-DOWN ON/OFF TIMER

- After setting, the time displayed on the LCD will automatically count down by 1 hour for every 1 hour that passes.
 For example, if the OFF TIMER is set to 3 hours, the display will change as follows: 3hr → 2hr → 1hr → blank (OFF)

Switching between ON/OFF TIMER display modes (24 hour clock and hours remaining display)

- When changing timer display modes (from 24 HOUR ON/OFF TIMER to COUNT UP-DOWN ON/OFF TIMER or vice versa), the timer cancels.
 The timer must be set again to activate it.



WEEKLY TIMER Operation

Up to 4 timer settings can be saved for each day of the week. This is convenient to adapt the WEEKLY TIMER to your family's life style.

Setting example of the WEEKLY TIMER

The same timer settings are used from Monday through Friday, while different timer settings are used for the weekend.

<p>[Monday]</p>	<p>Make timer settings for programs 1-4. ▶ Page 30</p> <p>program 1 program 2 program 3 program 4</p> <p>ON OFF ON OFF</p> <p>6:00 8:30 17:30 22:00</p>
<p>[Tuesday to Friday]</p>	<p>Use the copy mode to make settings for Tuesday to Friday, because these settings are the same as those for Monday. ▶ Page 32</p> <p>program 1 program 2 program 3 program 4</p> <p>ON OFF ON OFF</p> <p>6:00 8:30 17:30 22:00</p>
<p>[Saturday]</p>	<p>No timer settings</p>
<p>[Sunday]</p>	<p>Make timer settings for programs 1-4. ▶ Page 30</p> <p>program 1 program 2 program 3 program 4</p> <p>ON OFF OFF ON</p> <p>8:00 10:00 19:00 21:00</p>

- Up to 4 reservations per day and 28 reservations per week can be set using the WEEKLY TIMER. The effective use of the copy mode simplifies timer programming.
- The use of ON-ON-ON-ON settings, for example, makes it possible to schedule operating mode and set temperature changes. Furthermore, by using OFF-OFF-OFF-OFF settings, only the turn off time of each day can be set. This will turn off the air conditioner automatically if you forget to turn it off.

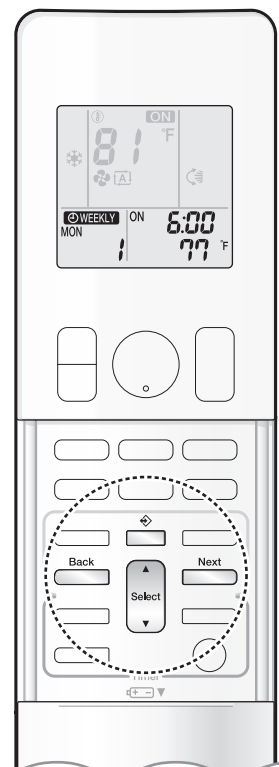

To use WEEKLY TIMER operation

Setting mode

- Make sure the day of the week and time are set.
If not, set the day of the week and time. ▶Page 11

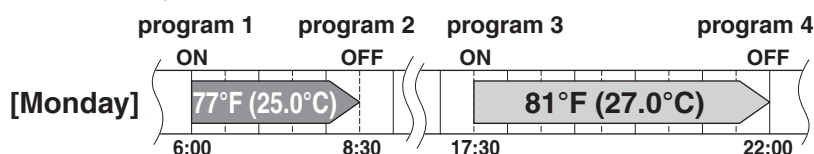

Setting Displays

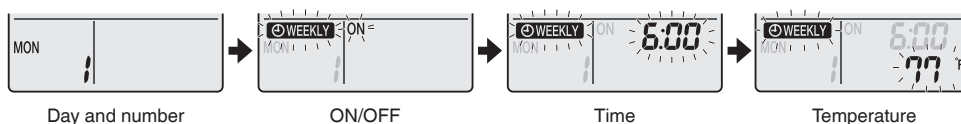

1. Press .

- The day of the week and the reservation number of the current day will be displayed.
- 1 to 4 settings can be made per day.

2. Press to select the desired day of the week and reservation number.

- Pressing  changes the reservation number and the day of the week.

3. Press .

- The day of the week and reservation number will be set.
- “ WEEKLY” and “ON” blink.

4. Press to select the desired mode.

- Pressing  changes the “ON” or “OFF” setting in sequence.



- In case the reservation has already been set, selecting “blank” deletes the reservation.
- Proceed to **STEP 9** if “blank” is selected.
- To return to the day of the week and reservation number setting, press .

5. Press .

- The ON/OFF TIMER mode will be set.
- “ WEEKLY” and the time blink.



WEEKLY TIMER Operation

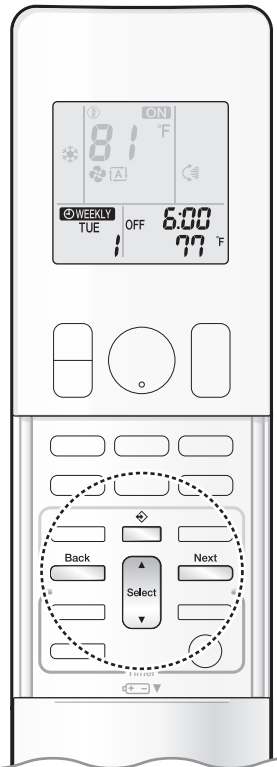

6. Press to select the desired time.

- The time can be set between 0:00 and 23:50 in 10-minute intervals.
- To return to the ON/OFF TIMER mode setting, press .
- Proceed to **STEP 9** when setting the OFF TIMER.

7. Press .

- The time will be set.
- “ WEEKLY” and the temperature blink.

8. Press to select the desired temperature.

- The temperature can be set between 50°F (10.0°C) and 90°F (32.0°C).
COOL or AUTO: The unit operates at 64°F (18.0°C) even if it is set at 50°F (10.0°C) to 63°F (17.0°C). **▶Page 14**
- HEAT or AUTO : The unit operates at 86°F (30.0°C) even if it is set at 87°F (30.5°C) to 90°F (32.0°C). **▶Page 14**
- To return to the time setting, press .
- The set temperature is only displayed when the mode setting is on.

9. Press .

- Check for a receiving tone and that the OPERATION lamp blinks twice.
- The TIMER lamp lights orange.
- Temperature and time are set in the case of ON TIMER operation, and the time is set in the case of OFF TIMER operation.
- The next reservation screen will appear.
- To continue further settings, repeat the procedure from **STEP 4**.

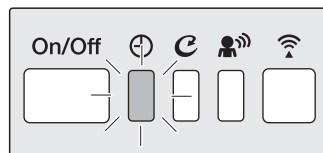



Display

10. Press to complete the setting.

- “ WEEKLY” is displayed on the LCD and WEEKLY TIMER operation is activated.
- A reservation made once can be easily copied and the same settings used for another day of the week. Refer to **Copy mode** . **▶Page 32**

NOTE

Notes on WEEKLY TIMER operation



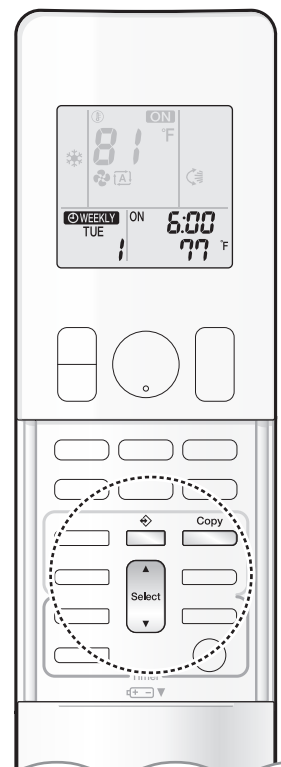



- Do not forget to set the clock on the remote controller first. **▶Page 11**
- The day of the week, ON/OFF TIMER mode, time and set temperature (only for ON TIMER mode) can be set with the WEEKLY TIMER.
When set to ON TIMER mode, operation will begin in the settings used previously for operation mode, temperature, airflow rate, and airflow direction.
- WEEKLY TIMER and ON/OFF TIMER operation cannot be used at the same time. The ON/OFF TIMER operation has priority if it is set while WEEKLY TIMER is still active. The WEEKLY TIMER will enter the standby state, and “ WEEKLY” will disappear from the LCD. When the ON/OFF TIMER is up, the WEEKLY TIMER will automatically become active.
- Turning off the circuit breaker, power failure, and other similar events will render operation of the indoor unit's internal clock inaccurate. Reset the clock. **▶Page 11**
-  can be used only for the time and temperature settings. It cannot be used to go back to the reservation number.

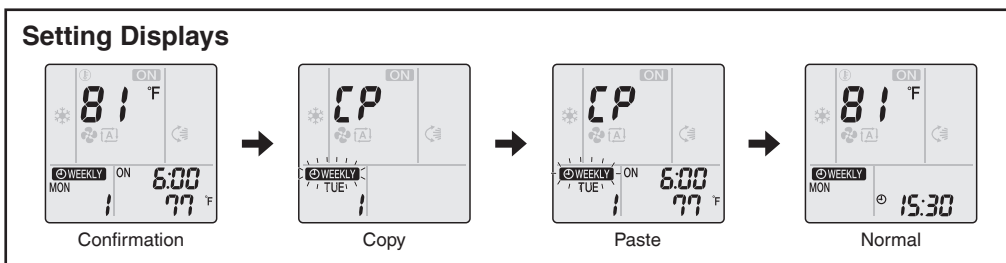
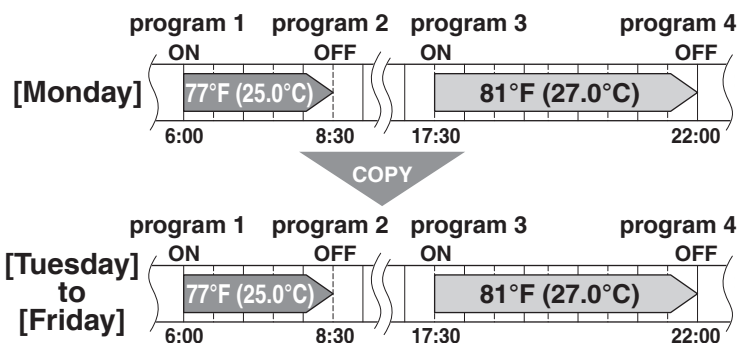

Copy mode



- A reservation made once can be copied to another day of the week. The whole reservation of the selected day of the week will be copied.



1. Press .
2. Press  to confirm the day of the week to be copied.
3. Press .
 - The whole reservation of the selected day of the week will be copied.
4. Press  to select the destination day of the week.
5. Press .
 - Check for a receiving tone and that the OPERATION lamp blinks twice.
 - The reservation will be copied to the selected day of the week. The whole reservation of the selected day of the week will be copied.
 - To continue copying the settings to other days of the week, repeat **STEP 4** and **STEP 5**.
6. Press  to complete the setting.
 - “ WEEKLY” is displayed on the LCD and WEEKLY TIMER operation is activated.

NOTE

Note on COPY MODE

- The entire reservation of the source day of the week is copied in the copy mode.
 In the case of making a reservation change for any day of the week individually after copying the content of weekly reservations, press  and change the settings in the steps of **Setting mode**.  **Page 30**



WEEKLY TIMER Operation

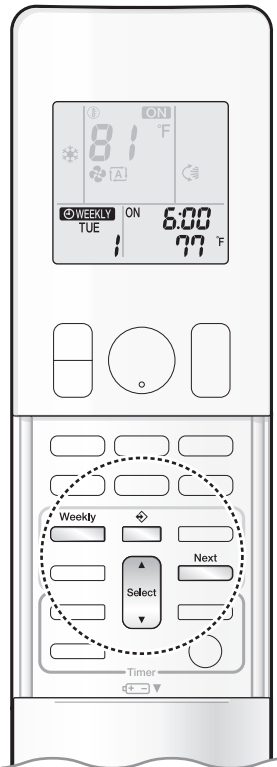

Confirming a reservation

- The reservation can be confirmed.

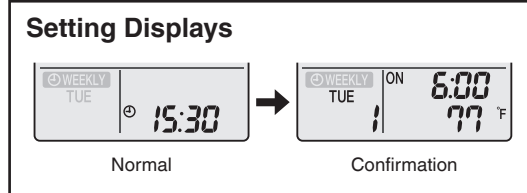

1. Press .

- The day of the week and the reservation number of the current day will be displayed.

2. Press to select the day of the week and the reservation number to be confirmed.

- Pressing displays the reservation details.
- To change the confirmed reserved settings, select the reservation number and press . The mode is switched to setting mode. Proceed to **Setting mode STEP 4.** [▶Page 30](#)

3. Press to exit the confirmation mode.

- “ ” is displayed on the LCD and WEEKLY TIMER operation is activated.

To deactivate WEEKLY TIMER operation

Press while “ ” is displayed on the LCD.

- “ ” disappears from the LCD.
- The TIMER lamp goes off.
- To reactivate the WEEKLY TIMER operation, press again.
- If a reservation deactivated with is activated once again, the last reservation mode will be used.

NOTE

- If not all the reservation settings are reflected, deactivate the WEEKLY TIMER operation once. Then press again to reactivate the WEEKLY TIMER operation.

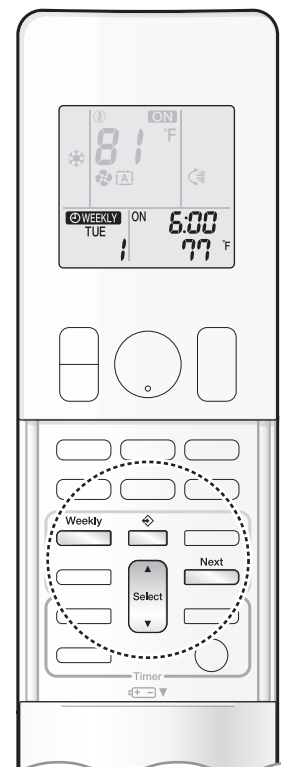

To delete reservations

An individual reservation

1. Press .

- The day of the week and the reservation number will be displayed.

2. Press **to select the day of the week and the reservation number to be deleted.**

3. Press .

- “ WEEKLY” and “ON” or “OFF” blink.

4. Press **until no icon is displayed.**

- Pressing changes the ON/OFF TIMER mode in sequence.
- Selecting “blank” will cancel any reservation you may have.



5. Press .

- Check for a receiving tone and that the OPERATION lamp blinks twice.
- The selected reservation will be deleted.

6. Press .

- If there are still other reservations, WEEKLY TIMER operation will be activated.

Reservations for each day of the week

- This function can be used for deleting reservations for each day of the week.
- It can be used while confirming or setting reservations.

1. Press .

- The day of the week and the reservation number will be displayed.

2. Press **to select the day of the week to be deleted.**

3. Hold **for about 5 seconds.**

- Check for a receiving tone and that the OPERATION lamp blinks twice.
- The reservation of the selected day of the week will be deleted.

4. Press .

- If there are still other reservations, WEEKLY TIMER operation will be activated.

All reservations

Hold **for about 5 seconds with the normal display.**

- Check for a receiving tone and that the OPERATION lamp blinks twice.
- “ WEEKLY” disappears from the LCD.
- The TIMER lamp goes off.
- All reservations will be deleted.
- This operation is not functional while the WEEKLY TIMER setting screen is displayed.



Wireless LAN connection

Wireless LAN connection



Web site: <https://daikincomfort.com/products/thermostats-controls/daikin-comfort-control-app>

For information on the latest version of Wireless LAN control, please see the web site above.
For instruction about how to operate the Daikin Comfort Control App application, please refer to the operation manual at the web site.

Contains FCC ID: VPYLB1YA

This device complies with part 15 of the FCC Rules. Operation is subject to the following two conditions:

- (1) This device may not cause harmful interference, and
- (2) This device must accept any interference received, including interference that may cause undesired operation.

FCC CAUTION

Changes or modifications not expressly approved by the party responsible for compliance could void the user's authority to operate the equipment. This transmitter must not be co-located or operated in conjunction with any other antenna or transmitter.

Contains IC: 772C-LB1YA

This device complies with Industry Canada's applicable licence-exempt RSSs.

Operation is subject to the following two conditions:

- (1) This device may not cause interference; and
- (2) This device must accept any interference, including interference that may cause undesired operation of the device.

This equipment complies with IC radiation exposure limits set forth for an uncontrolled environment and meets RSS-102 of the IC radio frequency (RF) Exposure rules. This equipment should be installed and operated keeping the radiator at least 7-7/8 inches (20cm) or more away from person's body.

The FCC responsible party is Goodman Manufacturing Company, L.P., and may be contacted by calling (713)-861-2500, or at 19001 Kermier Rd., Waller, TX 77484.

(www.GoodmanMFG.com)

This device, which was assembled by Goodman manufacturing Company, L.P., contains a component that is classified as an intentional radiator.

This intentional radiator has been certified by the FCC: FCC ID VPYLB1YA.

And this intentional radiator has an industry Canada ID: IC 772C-LB1YA.

The manufacturer of the intentional radiator (model no. Type1YA) is Murata Manufacturing co., Ltd (www.murata.com).

This equipment complies with FCC radiation exposure limits set forth for an uncontrolled environment and meets the FCC radio frequency (RF) Exposure Guidelines. This equipment should be installed and operated keeping the radiator at least 7-7/8 inches (20cm) or more away from person's body.

Changes or modifications not expressly approved by the party responsible for compliance could void the user's authority to operate the equipment.

NOTE: This equipment has been tested and found to comply with the limits for a Class B digital device, pursuant to part 15 of the FCC Rules. These limits are designed to provide reasonable protection against harmful interference in a residential installation. This equipment generates, uses and can radiate radio frequency energy and, if not installed and used in accordance with the instructions, may cause harmful interference to radio communications. However, there is no guarantee that interference will not occur in a particular installation. If this equipment does cause harmful interference to radio or television reception, which can be determined by turning the equipment off and on, the user is encouraged to try to correct the interference by one or more of the following measures:

- Reorient or relocate the receiving antenna.
- Increase the separation between the equipment and receiver.
- Connect the equipment into an outlet on a circuit different from that to which the receiver is connected.
- Consult the dealer or an experienced radio/TV technician for help.

Preparation before setup

Wi-Fi settings

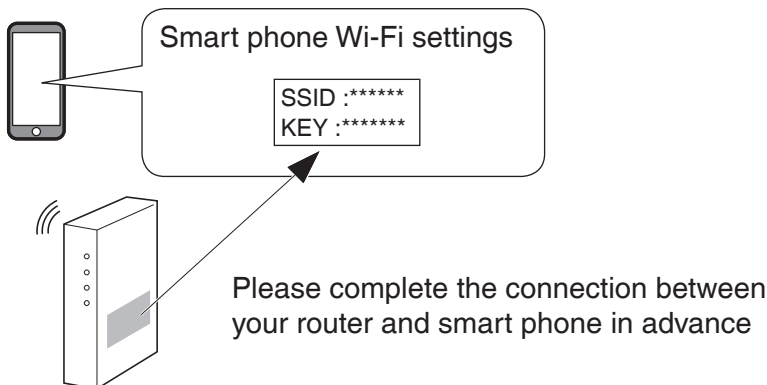

Application software installation

- Before downloading the application software for installing, please read “**Configuration**” on **▶Page 9**.

For Android Phones

- 1) Open [Google Play].
- 2) Search using the application name:
[Daikin Comfort Control App].
- 3) Follow the directions on the screen to install.

For iOS Phones

- 1) Open the [App Store].
- 2) Search using the application name:
[Daikin Comfort Control App].
- 3) Follow the directions on the screen to install.

- After installing the app, it is necessary to accept the terms of the license agreement on the app license agreement screen.

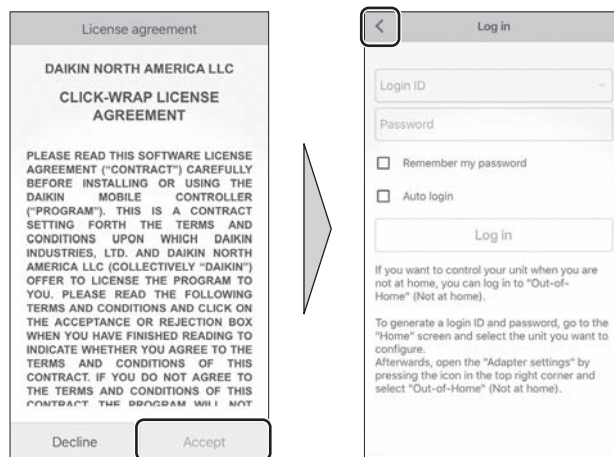

Tap the back arrow to return to the home screen

Attention

- The actual application screen layout and content may differ from what is shown. The layout and content of the application screen is subject to change without notice.

Setup procedure

The setup procedure will be different depending on if your home router has a WPS button or not.

WPS button

Step 1: Connect the air conditioner to your home network.

Described on **▶Page 37**.

No WPS button

Step 1: Connect the air conditioner to your home network.

Described on **▶Page 38**.

Step 2: Creating a login

Described on **▶Page 39**.



Wireless LAN connection

WPS button

Step 1: Connect the air conditioner to your home network.

1. While operation is stopped, press  and hold the button for 5 seconds.

2. Press  or  and select menu number **2**.

- “SP” appears on the LCD.
- “2” blinks.

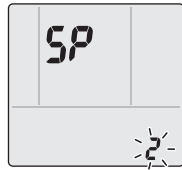

3. Press  to confirm the WPS selected setting.

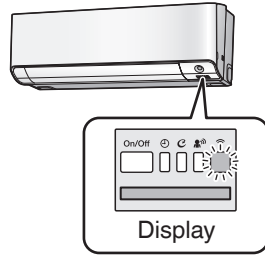

The wireless LAN connection adapter lamp blinks more quickly.

4. Press the WPS button on your communication device (router, for example) within approximately 1 minute. Refer to the manual of your communication device.

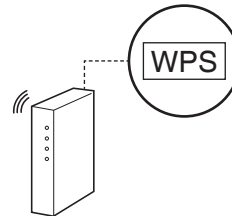

Router <image>

5. When the wireless LAN connection adapter lamp switches from blinking to lit, connection of the wireless LAN connection adapter is complete.

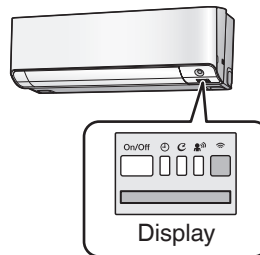

The wireless LAN connection adapter lamp lights.

If the wireless LAN connection adapter lamp turns off, repeat steps (2) to (4) again. If you still cannot connect, follow the procedure on page 3, which describes how to connect without using the WPS button.

6. Press  to return to the default screen. No more settings need to be carried out from the remote controller.

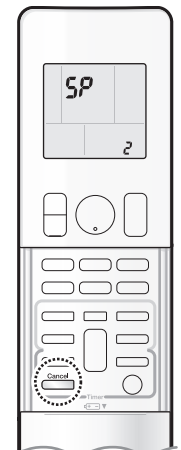
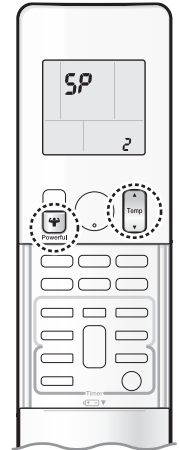



No WPS button

Even if your router has a WPS button but you simply do not use the WPS function, you can follow the connection procedure below.

Step 1: Connect the air conditioner to your home network.

1. While operation is stopped, press  and hold the button for 5 seconds.

2. Press  or  and select menu number 3.

- “SP” appears on the LCD.
- “3” blinks.

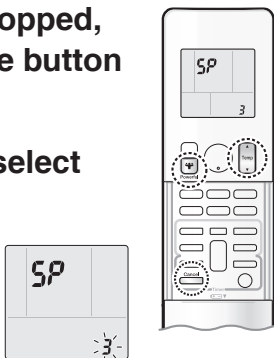

3. Press  to connect to the access point.

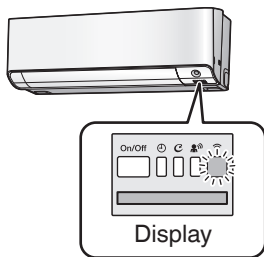

The wireless LAN connection adapter lamp blinks for 1 second.

4. Press  to return to the default screen. No more settings need to be carried out from the remote controller.

5. Open the Wi-Fi setting screen of your smart phone, select the SSID printed on the label, and input the KEY number.



Select the SSID printed on the label attached to the unit or the operation manual, then input the KEY number.

WIRELESS LAN CONNECTION
SSID:DaikinAPXXXXX.
KEY :YYYYYYYYYYYYY.

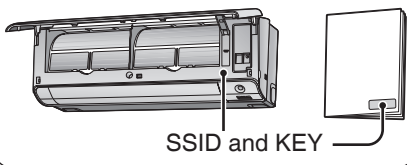

6. Open the Daikin Comfort Control App and tap “Configure the wireless connection”.

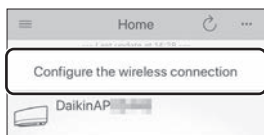

7. Tap the SSID of your router, input the password, and tap to connect.



8. Make sure that the wireless LAN connection adapter lamp has changed from blinking to lit. After it has changed, tap “On continuously”.

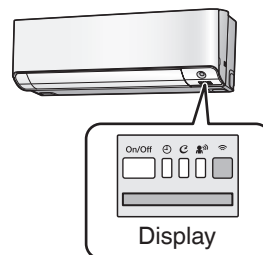
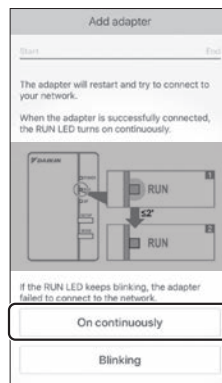

The wireless LAN connection adapter lamp lights.

An external type wireless LAN connection adapter is shown in the illustrations. Air conditioner models with a built-in wireless LAN connection adapter will differ from the illustrations. Regardless of whether your wireless LAN connection adapter is external or built-in, perform setting in accordance with this setup guide.

9. Reconnect your smart phone to your router with Wi-Fi. Open the Wi-Fi setting screen of your smart phone and connect to your router. Connection of the wireless LAN connection adapter is complete.



If connection is impossible, follow the procedures in “To reset the connection setting to the factory default” [▶ Page 40](#) and after reset is complete, repeat steps (1) through (9) again.



Proceed to “Step 2: Creating a login” on [▶ Page 39](#).



Wireless LAN connection

Step 2: Creating a login

1. Open the app and tap the connected unit name. Tap  in the upper right.

- If the unit name is not displayed, tap  in the upper right. If the unit name still does not appear, wait 30 seconds and then tap  again.

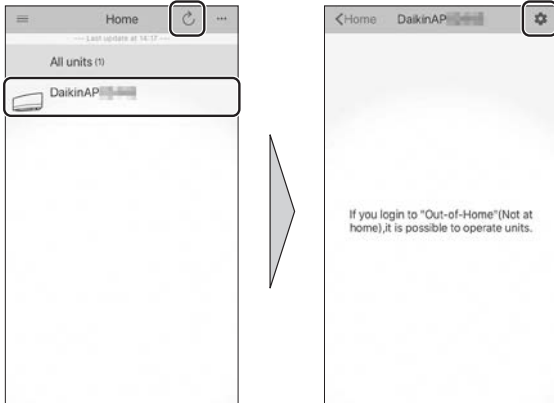

2. Tap “Out-of-Home” (Not at home) under “Adapter network settings”.



3. Tap the slider next to “Out-of-Home” (Not at home) operation.

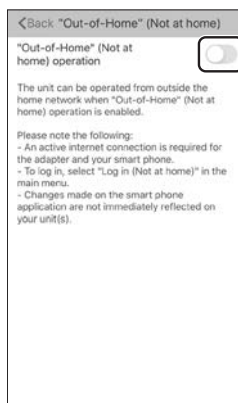



4. Set a login ID and tap “Next”.

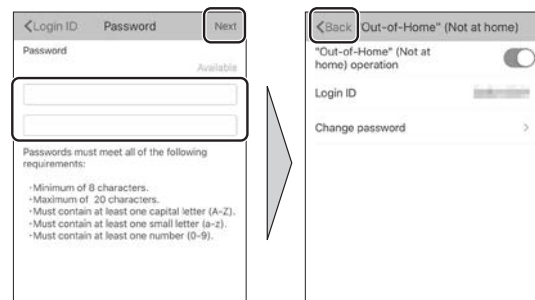

5. Set a password and tap “Next”. Tap the back arrow to return to the home screen.



6. Tap  in the upper left, then tap Log in (Not at home) “Out-of-Home”. Input the login ID and password you chose in the previous step, then tap the “Log in” button.

- It may take several minutes for the unit name to be displayed after login. Tap  in the upper right to refresh.

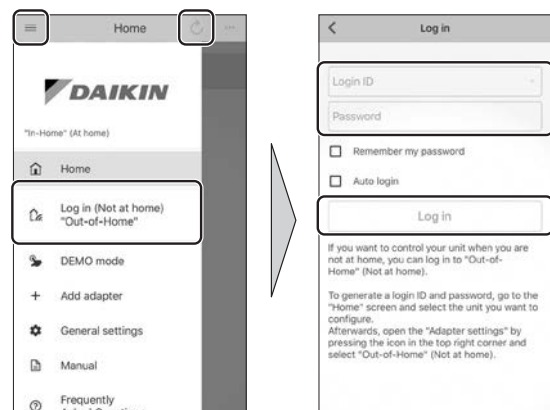

After login is complete, you will be able to operate the air conditioner.

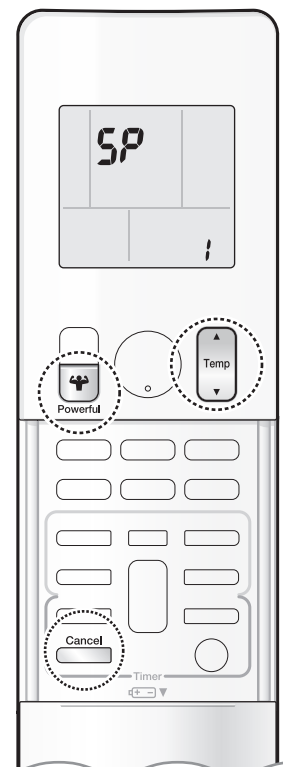

To confirm the wireless LAN connection adapter connection

■ To confirm

1. While operation is stopped, press  and hold the button for 5 seconds.
2. Press  to confirm the selected setting.

- “SP” appears on the LCD.
- “!” blinks.



Check the indoor unit LED.

Wireless LAN connection adapter lamp	Status
Blinking for 1 second	Communication is OK
Blinking for 3 seconds	Please initialize the wireless LAN connection adapter
Does not blink or light	Communication is abnormal There is a possibility of equipment failure Please request repair



To turn off the wireless connection

■ To use the remote controller

1. While operation is stopped, press  and hold the button for 5 seconds.
2. Press  or  and select menu **OFF**.

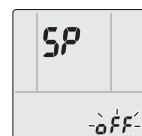
- “SP” appears on the LCD.
- “OFF” blinks, and communication is OFF.



3. Press  and hold the button for 2 seconds to confirm selected setting.
 - The wireless LAN connection adapter lamp turn off.
4. Press  to return to the default screen.

To reset the connection setting to the factory default



- If you want to reset the connection settings, it is possible to initialize the wireless LAN connection adapter to its factory default state. If initialized, data including the network settings and power consumption history will be erased.
- When discarding or transferring to another user, initialize the connection adapter to erase the internal data.

■ To reset

1. While operation is stopped, press  and hold the button for 5 seconds.
2. Press  or  and select menu **R**.

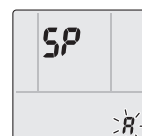
- “SP” appears on the LCD.
- “R” blinks.



3. Press  and hold the button for 2 seconds to confirm selected setting.
 - The wireless LAN connection adapter lamp blinks for 1 second.
4. Press  to return to the default screen.

NOTE

Note on wireless LAN operation

- If the LED display is distracting, change the brightness setting. ▶ [Page 12](#)

Care and Cleaning

⚠ CAUTION

- Before cleaning, be sure to stop the operation and turn off the circuit breaker.
- Do not touch the aluminum fins of the indoor unit. If you touch those parts, this may cause an injury.

■ Quick reference

Cleaning parts

Front panel

- Wipe with a soft cloth which has been moistened with water or neutral detergent.
- Wipe with a soft dry cloth.

If dirty



Air filter

- Vacuum dust or wash the filter.

Once every 2 weeks

▶Page 42

Titanium apatite deodorizing filter

- Vacuum dust or replace the filter.

[Cleaning]

Once every 6 months

▶Page 43

[Replacement]

Once every 3 years

▶Page 43

Indoor unit and remote controller

- Wipe them with a soft cloth.

If dirty

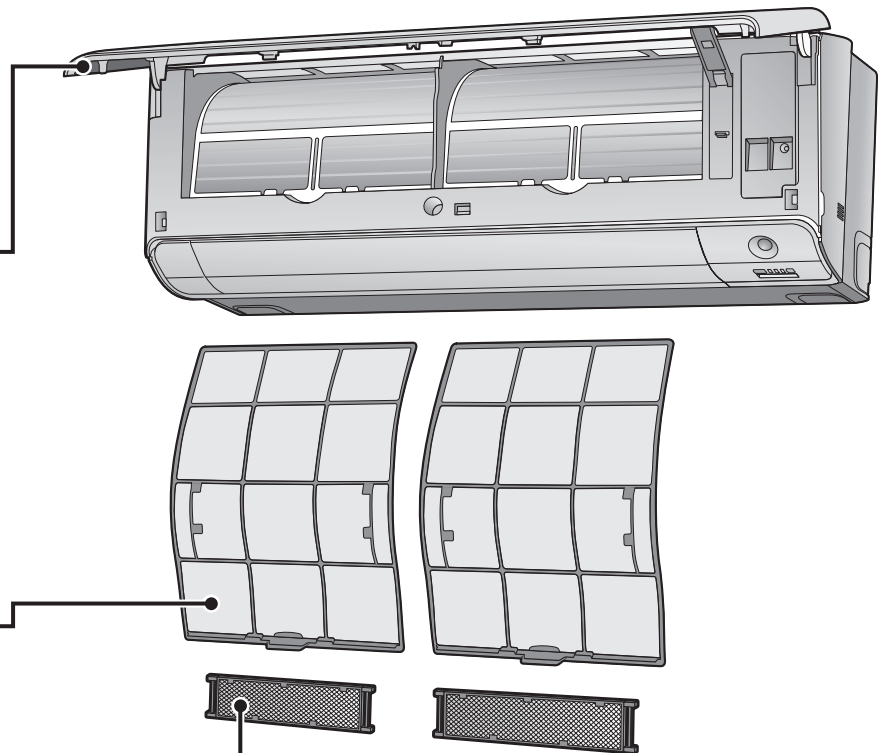

NOTE

For cleaning, do not use any of the following:

- Water hotter than 104°F (40.0°C)
- Volatile liquid such as benzine, gasoline and thinner
- Polishing compounds
- Rough materials such as a scrubbing brush
- Sprays such as deodorizers



! CAUTION

- When removing or attaching the front panel, stand on a solid, stable base and take care not to fall.
- When removing or attaching the front panel, support the panel securely with your hand to prevent it from falling.

■ Air filter

1. Open the front panel.

- Hold the front panel by the sides and open it.

Backside of the front panel

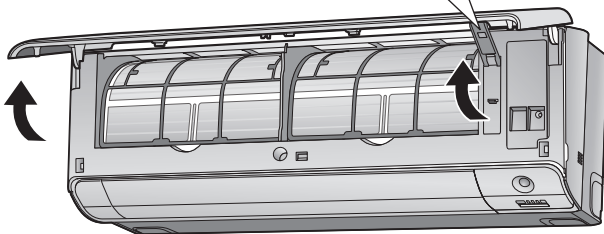
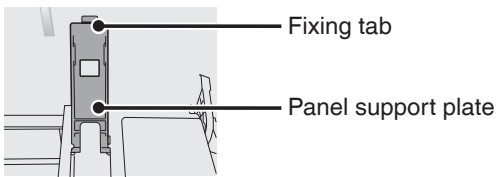

2. Pull out the air filters.

- Push the filter tab at the center of each air filter a little upwards, then pull it down.

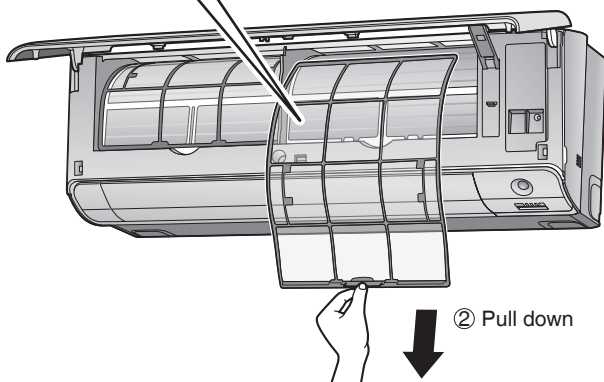
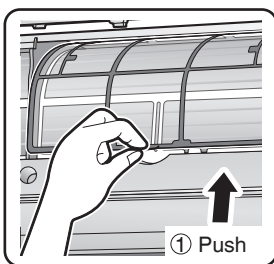

3. Wash the air filters with water or clean them with a vacuum cleaner.

- It is recommended to clean the air filters every 2 weeks.

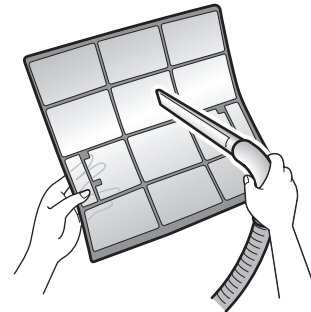

If the dust does not come off easily

- Wash the air filters with neutral detergent thinned with lukewarm water, then dry them up in the shade.

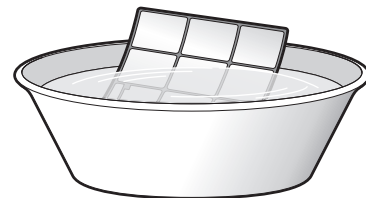

4. Reattach the filters.

5. Close the front panel slowly.

- Press the panel at both sides and in the central area.

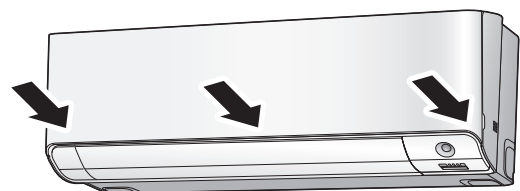

- Make sure that the front panel is securely fixed.

Care and Cleaning

■ Titanium apatite deodorizing filter

1. Open the front panel and pull out the air filters. ▶Page 42

2. Take off the titanium apatite deodorizing filters.

- Hold the recessed parts of the frame and unhook the 4 claws.
- Remove the filters from the tabs.

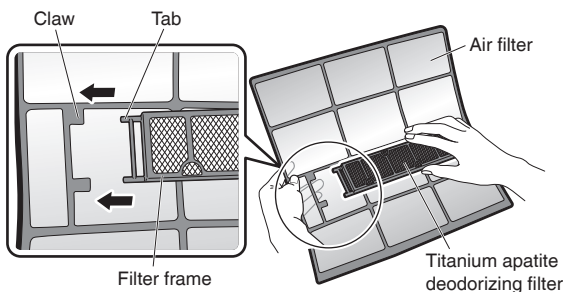

3. Clean or replace the titanium apatite deodorizing filters.

[Cleaning]

3-1 Vacuum dust, and soak in lukewarm water or water for about 10 to 15 minutes if very dirty.

- Do not remove the filter from the frame when washing with water.

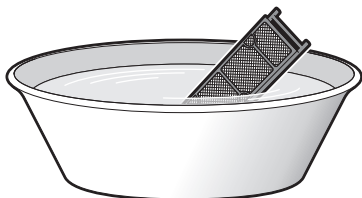

3-2 After washing, shake off remaining water and let them dry in the shade.

- Do not wring out the filter to remove water from it.

[Replacement]

Remove the filter from the filter frame and attach a new one.

- Do not throw away the filter frame. Reuse the filter frame when replacing the titanium apatite deodorizing filter.
- When attaching the filter, check that the filter is properly set in the tabs.

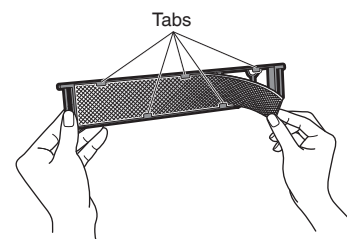

- Dispose of the old filter as non-flammable waste.

4. Set the titanium apatite deodorizing filters as they were.

5. Reattach the filters. ▶Page 42

6. Close the front panel slowly.

▶Page 42



NOTE

- Operation with dirty filters:
 - cannot deodorize the air,
 - cannot clean the air,
 - results in poor heating or cooling,
 - may cause odor.
- Dispose of old filters as non-flammable waste.
- To order a titanium apatite deodorizing filter, contact the dealer where you bought the air conditioner.

Item	Titanium apatite deodorizing filter (without frame) 1 set (2 pieces)
Part No.	KAF970A46

■ Prior to a long period of non-use

1. Operate the FAN mode for several hours on a mild day to dry out the inside.

- 1) Press  and select “”.
- 2) Press  and start the operation.

2. After operation stops, turn off the circuit breaker for the room air conditioner.

3. Clean the air filters and reattach them.

4. To prevent battery leakage, take out the batteries from the remote controller.

- When starting to use the air conditioner again, make sure that the drain hose outlet is not blocked, then turn on the circuit breaker.
An operational check of each component will be carried out automatically. (Also, put the batteries into the remote controller.)

■ We recommend periodical maintenance

- In certain operating conditions, the inside of the air conditioner may get foul after several seasons of use, resulting in poor performance. It is recommended to have periodical maintenance by a qualified contractor in addition to regular cleaning by the user.
- For qualified contractor maintenance, please contact the dealer where you bought the air conditioner.

FAQ

Indoor unit

The flaps do not start swinging immediately.

- The air conditioner is adjusting the position of the flaps. The flaps will start moving soon.

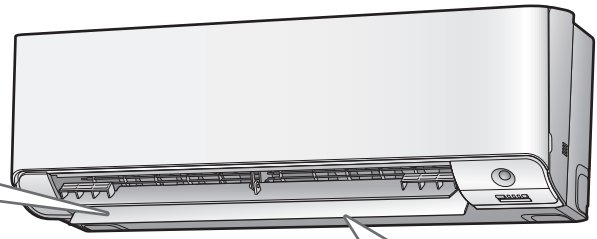

The air conditioner stops generating airflow during HEAT operation.

- Once the set temperature is reached, the airflow rate is reduced and operation stopped in order to avoid generating a cool airflow. Operation will resume automatically when the indoor temperature falls.

HEAT operation stops suddenly and a flowing sound is heard.

- The outdoor unit is defrosting. HEAT operation starts after the frost on the outdoor unit has been removed. This can take about 4 to 12 minutes.

Operation does not start soon.

- **When the unit is turned on again soon after being turned off.**
- **When the mode was reselected.**
 - This is to protect the air conditioner. You should wait for about 3 minutes.

Different sounds are heard.

- **A sound like flowing water**
 - This sound is generated because the refrigerant in the air conditioner is flowing.
 - This is a pumping sound of the water in the air conditioner and can be heard when the water is pumped out from the air conditioner during COOL or DRY operation.
- **Blowing sound**
 - This sound is generated when the flow of the refrigerant in the air conditioner is switched over.
 - If the outdoor temperature is low, this sound is generated when the direction of the flow of the refrigerant in the piping changes at the start of defrost operation, after HEAT operation is stopped and the room temperature is stabilized.
- **Ticking sound**
 - This sound is generated when the cabinet and frame of the air conditioner slightly expand or shrink as a result of temperature changes.
- **Whistling sound**
 - This sound is generated when refrigerant flows during defrosting operation.
- **Clicking sound during operation or idle time**
 - This sound is generated when the refrigerant control valves or the electrical parts operate.
- **Clopping sound**
 - This sound is heard from the inside of the air conditioner when the exhaust fan is activated while the room doors are closed. Open the window or turn off the exhaust fan.

Outdoor unit

Operating sound is loud.

- When frost forms on the heat exchanger of the outdoor unit, the operating sound level increases slightly.

The outdoor unit emits water or steam.

- **In HEAT operation**
 - The frost on the outdoor unit melts into water or steam when the air conditioner is in defrosting operation.
- **In COOL or DRY operation**
 - Moisture in the air condenses into water on the cool surface of the outdoor unit piping and drips.

Blowing sound

- If the outdoor temperature is low, this sound is generated when the direction of the flow of the refrigerant in the piping changes at the start of defrost operation, after HEAT operation is stopped and the room temperature is stabilized.

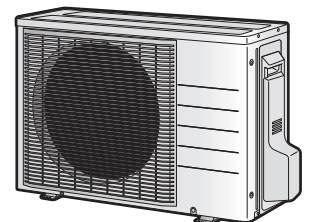

Troubleshooting

Before making an inquiry or a request for repair, please check the following.
If the problem persists, consult your dealer.



Not a problem

This case is not a problem.



Check

Please check again before requesting repairs.

The air conditioner does not operate

Case	Description / what to check
OPERATION lamp is off.	<ul style="list-style-type: none"> Has the circuit breaker been tripped or the fuse blown? Is there a power failure? Are batteries set in the remote controller?
OPERATION lamp is blinking.	<ul style="list-style-type: none"> Turn off the power with the circuit breaker and restart operation with the remote controller. If the OPERATION lamp is still blinking, check the error code and consult your dealer.

▶ Page 49, 50

The air conditioner suddenly stops operating

Case	Description / what to check
OPERATION lamp is on.	<ul style="list-style-type: none"> To protect the system, the air conditioner may stop operating after sudden large voltage fluctuations. It automatically resumes operation in about 3 minutes.
OPERATION lamp is blinking.	<ul style="list-style-type: none"> Are the air filters dirty? Clean the air filters. Is there anything blocking the air inlet or air outlet of the indoor unit or outdoor unit? Stop operation and after turning off the circuit breaker, remove the obstruction. Then restart operation with the remote controller. If the OPERATION lamp is still blinking, check the error code and consult your dealer.

▶ Page 49, 50

The air conditioner does not stop operating

Case	Description / what to check
The air conditioner continues operating even after operation is stopped.	<ul style="list-style-type: none"> Immediately after the air conditioner is stopped <ul style="list-style-type: none"> The outdoor unit fan continues rotating for about another 1 minute to protect the system. While the air conditioner is not in operation <ul style="list-style-type: none"> When the outdoor temperature is high, the outdoor unit fan may start rotating to protect the system.
	<ul style="list-style-type: none"> CLEAN operation is being performed. It is possible to stop CLEAN operation while it is in progress. (If this does not suit your preferences, set CLEAN to "Off".)

Wireless LAN connection

When this happens	Explanation and where to check
The device (air conditioner) cannot be found on the device list screen.	<ul style="list-style-type: none"> Carry out connection setting again. Move the router (wireless LAN access point) close to the indoor unit. ▶ Page 35-40 There is a possibility that you are using an unsupported smart phone or router (wireless LAN access point). For details, refer to the web site. ▶ Page 35-40
Even if the wireless LAN connection adapter lamp is lit, operation from outside the home is not possible.	<ul style="list-style-type: none"> Communication between the router and the internet connection may not be working. Please confirm.

Troubleshooting

The room does not cool down / warm up

Case	Description / what to check
Air does not come out.	<ul style="list-style-type: none"> <input checked="" type="checkbox"/> ■ In HEAT operation <ul style="list-style-type: none"> • To prevent the release of cold air, air does not come out directly after operation is started. Please wait 1 to 4 minutes. • During defrosting operation, hot air does not flow out of the indoor unit. ■ When the air conditioner operates immediately after the circuit breaker is turned on <ul style="list-style-type: none"> • The air conditioner is preparing to operate. Wait for about 3 to 10 minutes.
Air does not come out / Air comes out.	<ul style="list-style-type: none"> <input type="checkbox"/> ■ Is the airflow rate setting appropriate? <ul style="list-style-type: none"> • Is the airflow rate setting low, such as “Indoor unit quiet” or “Airflow rate 1”? Increase the airflow rate setting. ■ Is the set temperature appropriate? ■ Is the adjustment of the airflow direction appropriate? ■ Is the airflow rate set to AUTO in COOL operation? Or is the unit operating in DRY operation? <ul style="list-style-type: none"> • When the room temperature reaches the set temperature, the airflow rate will decrease to a gentle breeze in order to prevent over-cooling and overheating. When the room temperature deviates from the set temperature again, the gentle breeze will stop and the airflow will become stronger. Also, if the room temperature stabilizes near the set temperature, the airflow rate may repeatedly alter between strong and weak. (The unit may appear to be operating and stopping repeatedly, but this is not the case.)
Air comes out.	<ul style="list-style-type: none"> <input type="checkbox"/> • Is there any furniture directly under or beside the indoor unit? • Is the air conditioner in ECONO operation or QUIET OUTDOOR UNIT operation? ▶Page 25 • Are the air filters dirty? • Is there anything blocking the air inlet or air outlet of the indoor unit or outdoor unit? • Is a window or door open? • Is an exhaust fan turning? • Depending on the room conditions, number of occupants, or outdoor temperature and humidity, the set temperature may not be reached.



Water or mist comes out

Case	Description / what to check
Mist comes out of the indoor unit.	<ul style="list-style-type: none"> <input checked="" type="checkbox"/> • This happens when the air in the room is cooled into mist by the cold airflow during COOL or other operation.
Water is leaking from the indoor unit.	<ul style="list-style-type: none"> <input type="checkbox"/> • If the drain hose is crushed or clogged, water from the indoor unit may be unable to drain and start leaking. Stop operation of the unit immediately and contact your dealer.

Remote controller

Case	Description / what to check
The unit does not receive signals from the remote controller or has a limited operating range.	<ul style="list-style-type: none"> <input checked="" type="checkbox"/> • The batteries may be exhausted. Replace both batteries with new dry batteries AAA.LR03 (alkaline). For details, refer to “Preparation Before Operation”. ▶Page 10 • Signal communication may be disabled if an electronic-starter-type fluorescent lamp (such as inverter-type lamps) is in the room. Consult your dealer if that is the case. • The remote controller may not function correctly if the transmitter is exposed to direct sunlight. • Is there a device in the room that redirects remote controller signals? Some appliances such as TV speakers are equipped with these devices. If there is such a device in the room, the signals it emits may interfere with signals from the remote controller, preventing reception. • Infrared rays from smartphones and game consoles may interfere with signals from the remote controller, preventing reception.
LCD is faint, is not working, or the display is erratic.	<ul style="list-style-type: none"> <input checked="" type="checkbox"/> • The batteries may be exhausted. Replace both batteries with new dry batteries AAA.LR03 (alkaline). For details, refer to “Preparation Before Operation”. ▶Page 10

Remote controller

Case	Description / what to check
“  ” on the LCD is blinking and the remote controller cannot be operated.	<input checked="" type="checkbox"/> • Battery power has run out. Replace both batteries at the same time with new size AAA.LR03 (alkaline) batteries. Leaving exhausted batteries in the remote controller can result in injury due to battery leakage, rupturing or heating, or lead to equipment failure. (Even when the  is blinking, the OFF button remains functional.)
Other electric devices start operating.	<input checked="" type="checkbox"/> • If the remote controller activates other electric devices, move them away or consult your dealer.

Air has an odor

Case	Description / what to check
The air conditioner gives off an odor.	<input checked="" type="checkbox"/> • The room odor absorbed in the unit is discharged with the airflow. We recommend you to have the indoor unit cleaned. Please consult your dealer.
	<input checked="" type="checkbox"/> • The indoor unit is blowing out room odor it has absorbed (the smell of walls or carpeting, furniture, clothes, and so on). If the air conditioner has been used for a long time, there is a chance that a dirty heat exchanger or fan are emitting an odor. We recommend you to have the indoor unit cleaned. Please consult your dealer. Do not spray the air conditioner unit with any deodorizers.

Display lamps

Case	Description / what to check
The OPERATION lamp is off, but the air conditioner is operating.	<input type="checkbox"/> • Is the display brightness set to “Off”?
	<input checked="" type="checkbox"/> • CLEAN operation is being performed. It is possible to stop CLEAN operation while it is in progress. (If this does not suit your preferences, set CLEAN to “Off”.)
The display lamps on the main unit are dark.	<input type="checkbox"/> • Is the display brightness set to “Low”?

Others

Case	Description / what to check
The air conditioner suddenly starts behaving strangely during operation.	<input type="checkbox"/> • The air conditioner may malfunction due to lightning or radio. If the air conditioner malfunctions, turn off the power with the circuit breaker and restart the operation with the remote controller.
The WEEKLY TIMER does not operate according to the settings.	<input checked="" type="checkbox"/> • Check if the ON/OFF TIMER and the WEEKLY TIMER are set to the same time. Change or deactivate the settings in the ON/OFF TIMER. ▶Page 26, 27
The ON/OFF TIMER does not operate according to the settings.	<input checked="" type="checkbox"/> • Check if the ON/OFF TIMER and the WEEKLY TIMER are set to the same time. Change or deactivate the settings in the WEEKLY TIMER. ▶Page 29
The ceiling and walls around the indoor unit are black and dirty.	<input checked="" type="checkbox"/> • Due to the circulation pattern of the air and static electricity, the air conditioner is causing airborne dirt and dust to stick to walls and other surfaces. Depending on the wallpaper type, dirt may adhere more easily. A thorough cleaning of the area around the air conditioner is recommended.

Notes on the operating conditions

- If operation continues under any conditions other than those listed in the table,
 - A safety device may activate to stop the operation.
 - Dew may form on the indoor unit and drip from it when COOL or DRY operation is selected.

*1 Turning on switch SW on the outdoor unit PCB will extend the cooling operation range to 14°F (–10.0°C).
 Installing an air direction adjustment grille (sold separately) will further extend the operation range to –4°F (–20.0°C).
 Please consult your dealer.

*2 Installing a drain pan heater (sold separately) will further extend the heating operation range to –13°F (–25.0°C).
 Please consult your dealer.

Mode	Operating conditions
COOL / DRY	Outdoor temperature : 50*1-115°F (10.0*1-46.0°C) *1 –4°F (–20.0°C) if an air direction adjustment grille (sold separately) is installed. Indoor temperature : 64-90°F (18.0-32.0°C) Indoor humidity : 80% max.
HEAT	Outdoor temperature : 5*2-75°F (–15.0*2-24.0°C) *2 –13°F (–25.0°C) if a drain pan heater (sold separately) is installed. Indoor temperature : 50-86°F (10.0-30.0°C)

Troubleshooting

The OPERATION lamp blinks

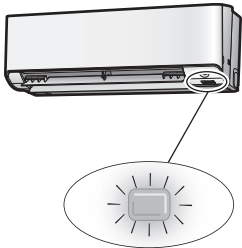

■ Check the interval time between blinks of the OPERATION lamp.

[Blink interval of about 0.5 seconds]

This is a notification of an abnormality.

Check the error code following the procedure below, and respond according to the instructions in the table.



■ Fault diagnosis by remote controller

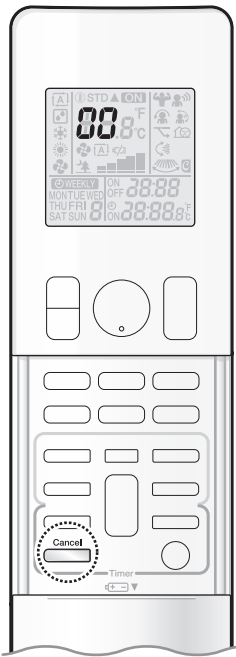

1. When  is held down for about 5 seconds, “00” blinks in the temperature display section.

2. While pointing the remote controller at the indoor unit, press  repeatedly.

A beep indicates a non-corresponding error code.

A long beep indicates a corresponding error code.

3. When a long beep is produced, check the error code and respond according to the instructions in the table.

- To cancel the code display, hold down  for about 5 seconds (the code display also clears if no button is pressed for a while).

CODE	Cause	Description / what to check
E7	The fan of the outdoor unit is stopped. • Is there any foreign matter inside the outdoor unit?	After turning off the circuit breaker, remove the foreign matter, then turn the power on again and operate.
L3, L4, L5	The temperature inside the outdoor unit has become too high, so operation has stopped. • Is there anything blocking the air outlet of the outdoor unit?	After turning off the circuit breaker, remove the obstruction, then turn the power on again and operate.
Other error codes, or if the error code cannot be checked		An abnormality has occurred.

In the case of error code **U0**, **F3** or **F8**

	CODE	MEANING
SYSTEM	00	NORMAL
	UA	INDOOR-OUTDOOR UNIT COMBINATION FAULT
	U0	REFRIGERANT SHORTAGE
	U2	DROP VOLTAGE OR MAIN CIRCUIT OVERVOLTAGE
	U4	FAILURE OF TRANSMISSION (BETWEEN INDOOR UNIT AND OUTDOOR UNIT)
INDOOR UNIT	A1	INDOOR PCB DEFECTIVENESS
	A5	HIGH PRESSURE CONTROL OR FREEZE-UP PROTECTOR
	A6	FAN MOTOR FAULT
	C4	FAULTY HEAT EXCHANGER TEMPERATURE SENSOR
	C9	FAULTY SUCTION AIR TEMPERATURE SENSOR
OUTDOOR UNIT	CC	FAULTY HUMIDITY SENSOR
	EA	COOLING-HEATING SWITCHING ERROR
	E1	CIRCUIT BOARD FAULT
	E3	HIGH PRESSURE SWITCH (HPS) ACTIVATED
	E5	OL (COMPRESSOR OVERLOAD) STARTED
	E6	FAULTY COMPRESSOR START UP
	E7	DC FAN MOTOR FAULT
	E8	OVERCURRENT INPUT
	F3	HIGH TEMPERATURE DISCHARGE PIPE CONTROL
	F6	HIGH PRESSURE CONTROL (IN COOLING)
	F8	OPERATION HALT DUE TO COMPRESSOR INTERNAL TEMPERATURE SENSOR FAULT
	H0	SENSOR FAULT
	H6	OPERATION HALT DUE TO FAULTY POSITION DETECTION SENSOR
	H8	DC CURRENT SENSOR FAULT
	H9	FAULTY SUCTION AIR TEMPERATURE SENSOR
	J3	FAULTY DISCHARGE PIPE TEMPERATURE SENSOR
	J6	FAULTY HEAT EXCHANGER TEMPERATURE SENSOR
	J8	FAULTY LIQUID PIPE TEMPERATURE SENSOR
	L3	ELECTRICAL PARTS HEAT FAULT
	L4	HIGH TEMPERATURE AT INVERTER CIRCUIT HEATSINK
L5	OUTPUT OVERCURRENT	
P4	FAULTY INVERTER CIRCUIT HEATSINK TEMPERATURE SENSOR	

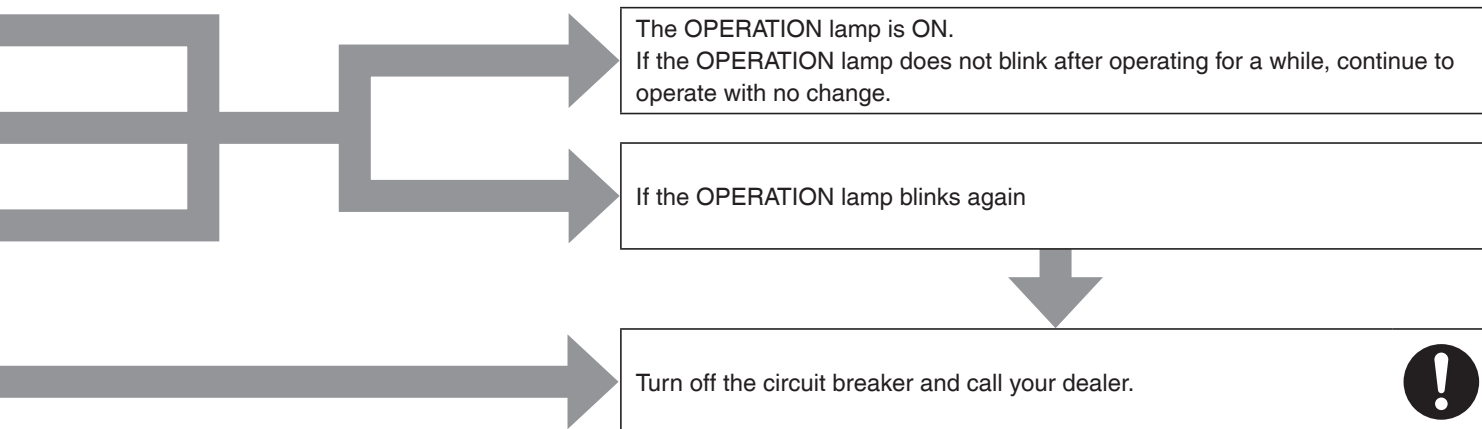

Troubleshooting

■ Call your dealer immediately

WARNING

When an abnormality (such as a burning smell) occurs, stop operation and turn off the circuit breaker.

- Continued operation in an abnormal condition may result in problems, electric shock or fire.
- Consult the dealer where you bought the air conditioner.

Do not attempt to repair or modify the air conditioner by yourself.

- Incorrect work may result in electric shock or fire.
- Consult the dealer where you bought the air conditioner.

If one of the following symptoms takes place, call your dealer immediately.

- The power cord is abnormally hot or damaged.
- An abnormal sound is heard during operation.
- The circuit breaker cuts off the operation frequently.
- A switch or a button often fails to work properly.
- There is a burning smell.
- Water leaks from the indoor unit.

Turn off the circuit breaker and call your dealer.



■ After a power failure

- The air conditioner automatically resumes operation in about 3 minutes. Please wait for a while.

■ Lightning

- If there is a risk lightning could strike in the neighborhood, stop operation and turn off the circuit breaker to protect the system.

■ Disposal requirements

- Dismantling of the unit, handling of the refrigerant, oil and other parts, should be done in accordance with the relevant local and national regulations.

MEMO

Quick Reference

DAIKIN NORTH AMERICA LLC

19001 Kermier Road
Houston, TX 77484
<https://www.northamerica-daikin.com/>



The two-dimensional bar code is a manufacturing code.

3P686871-1A M21B541A (2205) HT